

SANMOTION Stepping Motor

Stepping Motor Lineup

Lineup of Stepping Motors with Options for Various Application Needs

Stepping Motors with Encoders.....	p.2
Stepping Motors with Electromagnetic Brake.....	p.7
Stepping Motors with Gears	p.10

Stepping Motors with Encoders

2-Phase



Features

The encoder measures the motor velocity and the displacement.

- Device reliability is improved because it can monitor the motor step-out and position error.

Lineup

DC input 28 mm sq., 42 mm sq., 56 mm sq., 60 mm sq.

AC input 86 mm sq.

Compatible drivers

DC input Model no.: BS1D200P10

Operating current selection switch setting:

A (1 A/phase) for SH228 , SF242

0 (2 A/phase) for 103H712 , 103H782

- Drivers for 86 mm sq. motors (model no. SH286) are not included.

Encoder Specifications

Motor size	28 mm sq.	42 mm sq.	56 mm sq.	60 mm sq.	86 mm sq.
Motor model number	SH228 <input type="checkbox"/>	SF242 <input type="checkbox"/>	103H712 <input type="checkbox"/>	103H782 <input type="checkbox"/>	SH286 <input type="checkbox"/>
Resolution	500 × 4 = 2000 P/R	1000 × 4 = 4000 P/R	500 × 4 = 2000 P/R		4000 × 4 = 16000 P/R
Number of channels	2 ch	3 ch	2 ch		3 ch (Z phase: 51P/R)
Output method	Line driver (TTL)	Line driver (C-MOS)	Line driver (TTL)		Line driver (C-MOS)
Max. response frequency	30 kHz	55 kHz	30 kHz		220 kHz
Power supply voltage	5 VDC ± 5%				
Current consumption	140 mA max.	100 mA max.	140 mA max.		100 mA max.

● Maintain motor surface temperature at 85 °C or lower while in use.

● The user should not test the insulation resistance or dielectric strength because capacitors are inserted between the encoder output ground line and the frame to prevent noise.

Encoder pins

Motor size **28, 56, 60** mm sq.

Pin no.	Lead wire color	
A1	Blue	CHANNEL A
B1	Brown	CHANNEL \bar{A}
A2	Green	CHANNEL B
B2	Purple	CHANNEL \bar{B}
A3	Red	+5 V
B3	Black	0 V
A4	N.C	—
B4	Black	FG (SHIELD)

Motor size **42** mm sq.

Pin no.	
1	0 V
2	+5 V
3	CHANNEL \bar{Z}
4	CHANNEL Z
5	CHANNEL \bar{B}
6	CHANNEL B
7	CHANNEL \bar{A}
8	CHANNEL A

Motor size **86** mm sq.

Pin no.	Lead wire color	
A1	Blue	CHANNEL A
B1	Brown	CHANNEL \bar{A}
A2	Green	CHANNEL B
B2	Purple	CHANNEL \bar{B}
A3	White	CHANNEL Z
B3	Yellow	CHANNEL \bar{Z}
A4	Red	+5 V
B4	Black	0 V
A5	N.C	—
B5	N.C	—
A6	Black	FG (SHIELD)
B6	N.C	—

28 mm sq.

1.8° / step

RoHS

Bipolar, Lead wire type

Model number	Holding torque at 2-phase excitation [N·m] or larger	Rated current A / phase	Wiring resistance Ω / phase	Winding inductance mH / phase	Rotor inertia × 10 ⁻⁴ kg · m ²	Mass kg	Motor length (L) mm
SH2281-57XE20	0.07	1	2.6	1.85	0.01	0.15	59.25
SH2285-57XE20	0.145	1	3.75	3.4	0.022	0.25	78.5

SH2281-57XE20

Constant current circuit
Power supply voltage: 24 VDC
Operating current: 1 A / phase
At 2-phase excitation (full step)
 $J_r=0.01 \times 10^{-4} \text{kg} \cdot \text{m}^2$
(pulley balancer method)
fs: Maximum starting rate when not loaded

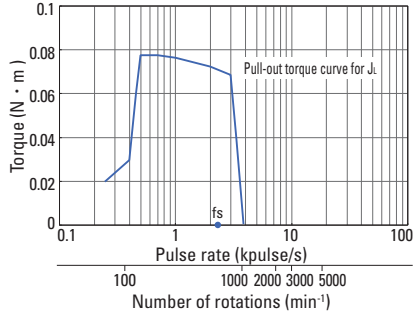

SH2285-57XE20

Constant current circuit
Power supply voltage: 24 VDC
Operating current: 1 A / phase
At 2-phase excitation (full step)
 $J_r=0.01 \times 10^{-4} \text{kg} \cdot \text{m}^2$
(pulley balancer method)
fs: Maximum starting rate when not loaded

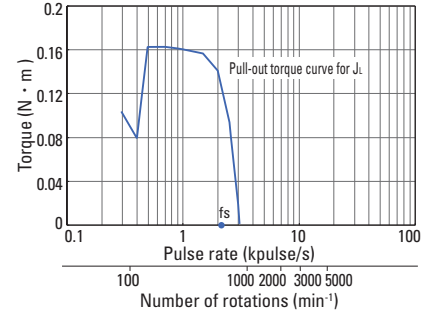

Dimensions [Unit: mm]

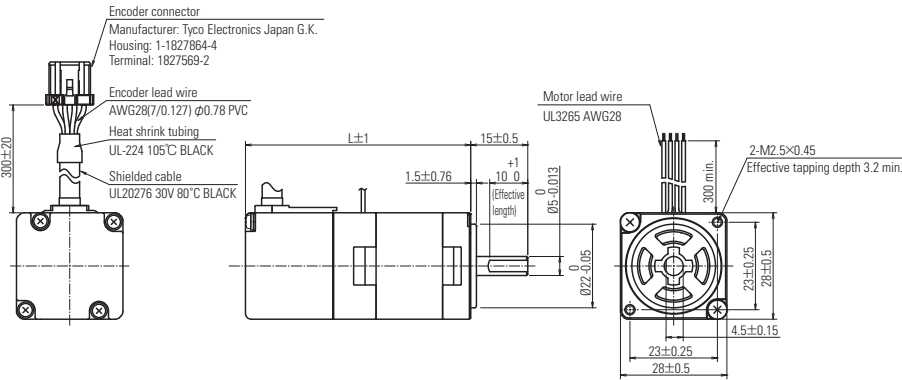

Stepping Motors with Encoders 2-Phase

42 mm sq.

1.8° / step

RoHS

Bipolar, Connector type

Model number	Holding torque at 2-phase excitation [N·m] or larger	Rated current A / phase	Wiring resistance Ω / phase	Winding inductance mH / phase	Rotor inertia × 10 ⁻⁴ kg · m ²	Mass kg	Motor length (L) mm
SF2421-10B41E	0.29	1	3.6	7	0.031	0.28	46.7
SF2422-10B41E	0.43	1	4.6	9.6	0.046	0.35	52.7
SF2423-10B41E	0.56	1	5.3	12.5	0.063	0.43	61.7
SF2424-10B41E	0.8	1	6.5	16	0.094	0.56	73.2

SF2421-10B41E

Constant current circuit
Power supply voltage: 24 VDC
Operating current: 1 A / phase
At 2-phase excitation (full step)
 $J_r=0.94 \times 10^{-4} \text{kg} \cdot \text{m}^2$
(when rubber coupling used)
fs: Maximum starting rate when not loaded

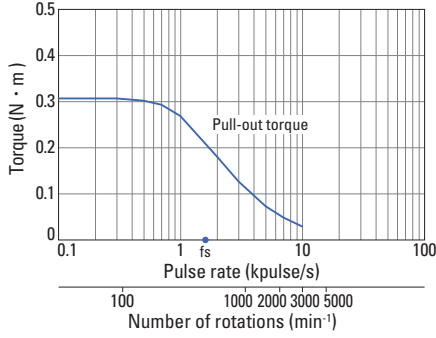

SF2422-10B41E

Constant current circuit
Power supply voltage: 24 VDC
Operating current: 1 A / phase
At 2-phase excitation (full step)
 $J_r=0.94 \times 10^{-4} \text{kg} \cdot \text{m}^2$
(when rubber coupling used)
fs: Maximum starting rate when not loaded

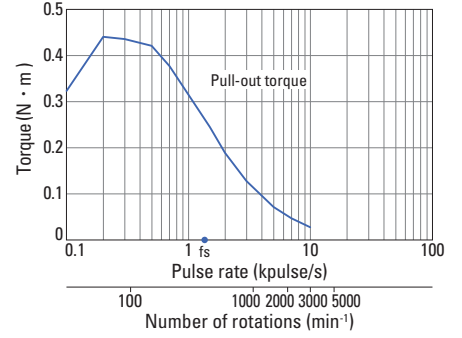

SF2423-10B41E

Constant current circuit
Power supply voltage: 24 VDC
Operating current: 1 A / phase
At 2-phase excitation (full step)
 $J_r=0.94 \times 10^{-4} \text{kg} \cdot \text{m}^2$
(when rubber coupling used)
fs: Maximum starting rate when not loaded

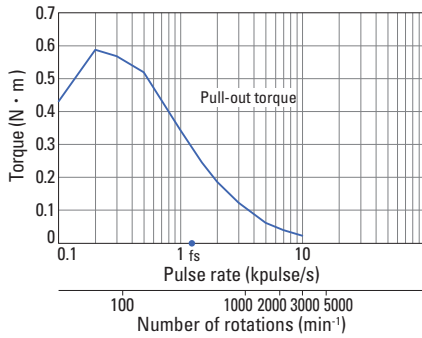

SF2424-10B41E

Constant current circuit
Power supply voltage: 24 VDC
Operating current: 1 A / phase
At 2-phase excitation (full step)
 $J_r=2.6 \times 10^{-4} \text{kg} \cdot \text{m}^2$
(when rubber coupling used)
fs: Maximum starting rate when not loaded

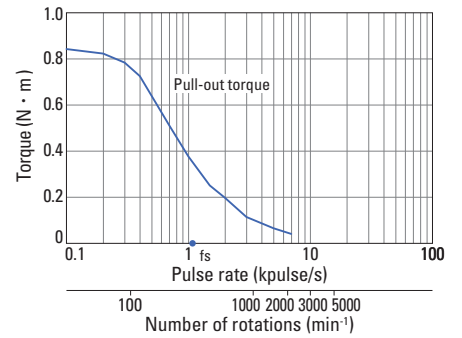

Dimensions [Unit: mm]

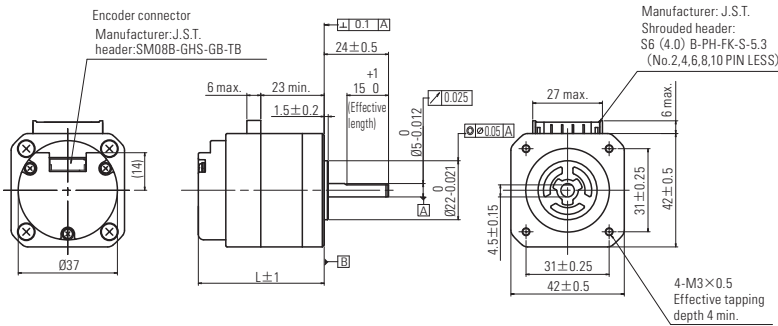

Option (sold separately): Motor cable model number: 4835775-1

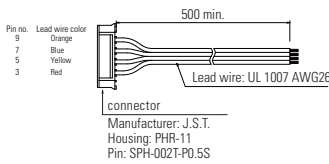

Option (sold separately): Encoder cable model number: 4835772-1

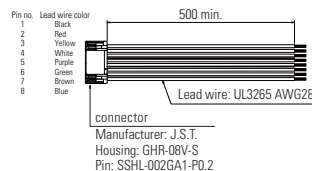

56 mm sq.

1.8° / step

RoHS

Bipolar, Lead wire type

Model number	Holding torque at 2-phase excitation [N·m] or larger	Rated current A / phase	Wiring resistance Ω / phase	Winding inductance mH / phase	Rotor inertia × 10 ⁻⁴ kg · m ²	Mass kg	Motor length (L) mm
103H7121-57XE20	0.55	2	1.1	3.7	0.1	0.51	55.3
103H7123-57XE20	1.0	2	1.5	7.5	0.21	0.69	67.3
103H7126-57XE20	1.6	2	2	9.1	0.36	1.02	89.3

103H7121-57XE20

Constant current circuit
Power supply voltage: 24 VDC
Operating current: 2 A / phase
At 2-phase excitation (full step)
J_r=0.94 × 10⁻⁴kg · m²
(when rubber coupling used)
fs: Maximum starting rate when not loaded

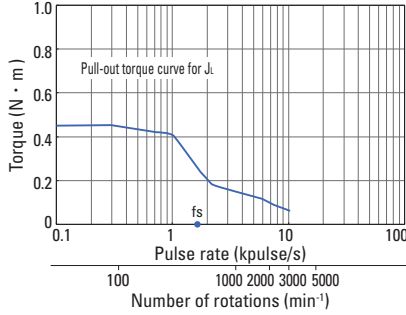

103H7123-57XE20

Constant current circuit
Power supply voltage: 24 VDC
Operating current: 2 A / phase
At 2-phase excitation (full step)
J_r=2.6 × 10⁻⁴kg · m²
(when rubber coupling used)
fs: Maximum starting rate when not loaded

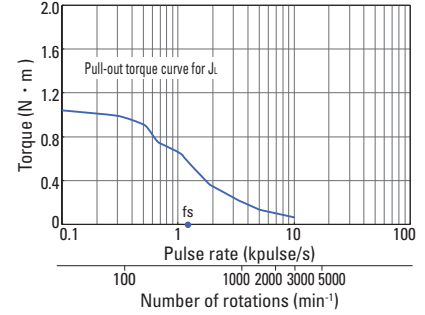

103H7126-57XE20

Constant current circuit
Power supply voltage: 24 VDC
Operating current: 2 A / phase
At 2-phase excitation (full step)
J_r=2.6 × 10⁻⁴kg · m²
(when rubber coupling used)
fs: Maximum starting rate when not loaded

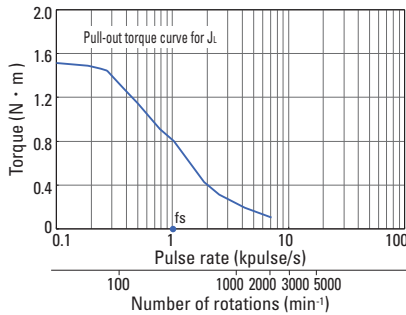

Dimensions [Unit: mm]

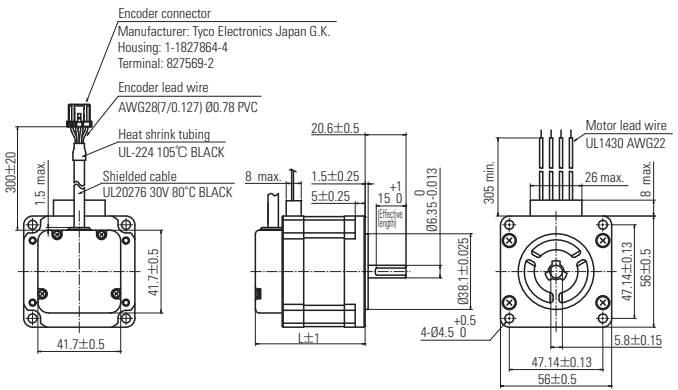

60 mm sq.

1.8° / step

RoHS

Bipolar, Connector type

Model number	Holding torque at 2-phase excitation [N·m] or larger	Rated current A / phase	Wiring resistance Ω / phase	Winding inductance mH / phase	Rotor inertia × 10 ⁻⁴ kg · m ²	Mass kg	Motor length (L) mm
103H7821-57XE20	0.88	2	1.27	3.3	0.275	0.64	58.3
103H7822-57XE20	1.37	2	1.55	5.5	0.4	0.81	67.3
103H7823-57XE20	2.7	2	2.4	9.5	0.84	1.38	99.3

103H7821-57XE20

Constant current circuit
Power supply voltage: 24 VDC
Operating current: 2 A / phase
At 2-phase excitation (full step)
J_r=2.6 × 10⁻⁴kg · m²
(when rubber coupling used)
fs: Maximum starting rate when not loaded

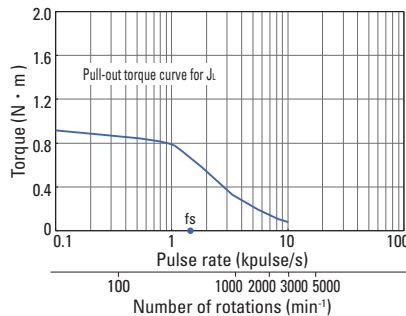

103H7822-57XE20

Constant current circuit
Power supply voltage: 24 VDC
Operating current: 2 A / phase
At 2-phase excitation (full step)
J_r=2.6 × 10⁻⁴kg · m²
(when rubber coupling used)
fs: Maximum starting rate when not loaded

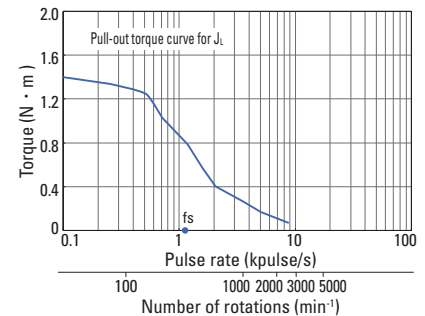

103H7823-57XE20

Constant current circuit
Power supply voltage: 24 VDC
Operating current: 2 A / phase
At 2-phase excitation (full step)
J_r=7.4 × 10⁻⁴kg · m²
(when rubber coupling used)
fs: Maximum starting rate when not loaded

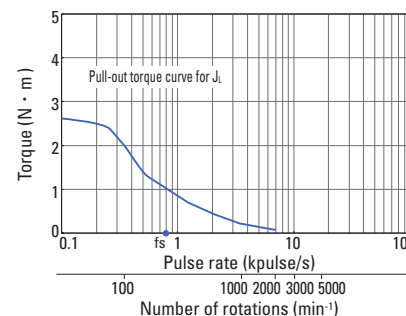

Dimensions [Unit: mm]

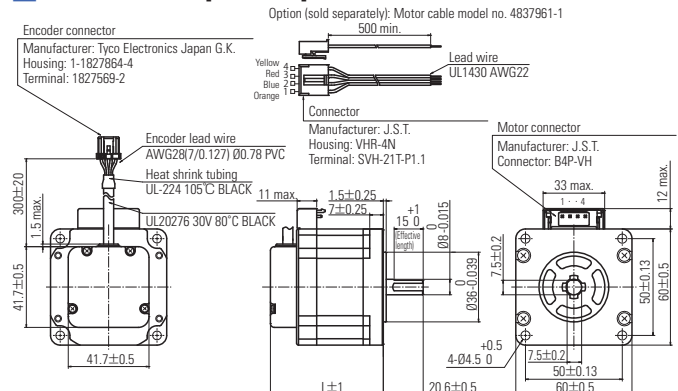

Stepping Motors with Encoders 2-Phase

86 mm sq. **1.8° / step** RoHS Bipolar, Cable type

Model number	Holding torque at 2-phase excitation	Rated current	Wiring resistance	Winding inductance	Rotor inertia	Mass	Motor length (L)
	[N·m] or larger	A / phase	Ω / phase	mH / phase	$\times 10^{-4} \text{kg} \cdot \text{m}^2$	kg	mm
SH2861-41XE41	3.3	4	0.58	3.7	1.48	1.8	79.5
SH2862-41XE41	6.4	4	0.85	6.4	3.0	2.95	110
SH2863-41XE41	9	4	1	7.9	4.5	4.05	140.5

SH2861-41XE41

Constant current circuit
 Power supply voltage: 100 VAC
 Operating current: 4 A / phase
 At 2-phase excitation (full step)
 $J_r = 15.3 \times 10^{-4} \text{kg} \cdot \text{m}^2$
 (when rubber coupling used)
 fs: Maximum starting rate when not loaded

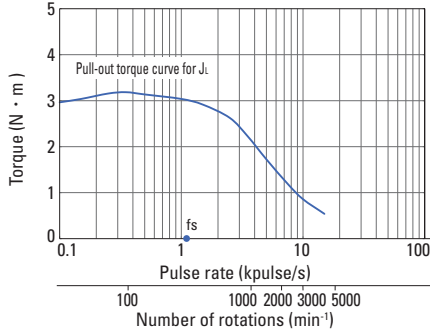

SH2862-41XE41

Constant current circuit
 Power supply voltage: 100 VAC
 Operating current: 4 A / phase
 At 2-phase excitation (full step)
 $J_r = 15.3 \times 10^{-4} \text{kg} \cdot \text{m}^2$
 (when rubber coupling used)
 fs: Maximum starting rate when not loaded

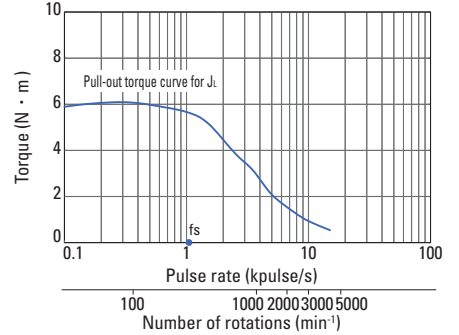

SH2863-41XE41

Constant current circuit
 Power supply voltage: 100 VAC
 Operating current: 4 A / phase
 At 2-phase excitation (full step)
 $J_r = 44 \times 10^{-4} \text{kg} \cdot \text{m}^2$
 (when rubber coupling used)
 fs: Maximum starting rate when not loaded

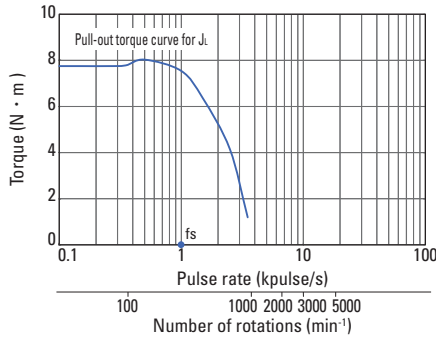

Dimensions [Unit: mm]

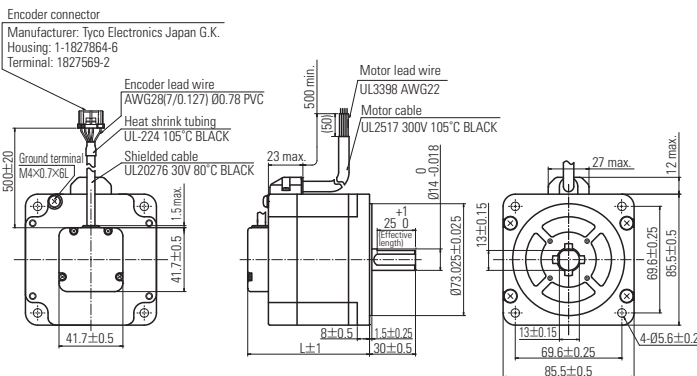

Stepping Motors with Electromagnetic Brake 2-Phase

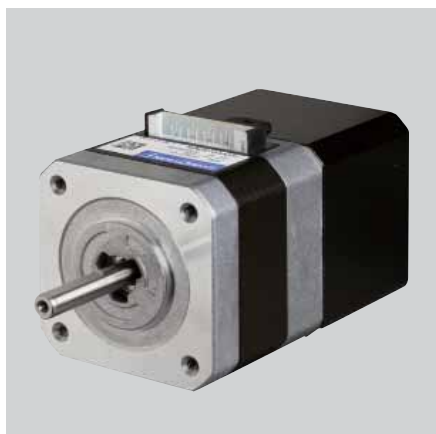

■ Features

Even in the event of power blackout, the EM brake holds the load in position.

- It is suitable for vertical operations or other likes.

■ Lineup

DC input 42 mm sq., 60 mm sq.

AC input 86 mm sq.

■ Compatible drivers

DC input Model no.: BS1D200P10

Operating current selection switch setting:

A (1 A/phase) for SF242

0 (2 A/phase) for 103H782

- Power supply for brake is necessary, besides the one for the driver.

- Drivers for 86 mm sq. motors (model no. SH286) are not included.

Brake Specifications Brake actuation: Power-off type*1

Motor size	—	42 mm sq.	60 mm sq.	86 mm sq.
Motor model number	—	SF242 <input type="checkbox"/>	103H782 <input type="checkbox"/>	SH286 <input type="checkbox"/>
Power supply voltage	—	24 VDC ± 5%		24 VDC ± 10%
Power consumption	W	2.4 (at 75 °C)	6 (at 75 °C)	10.5 (at 20 °C)
Static friction torque	N · m min.	0.3	0.8	5
Brake actuation time*2	ms max.	20		
Brake release time	ms max.	30		50
Polarity	—	+ : Brown, - : White	+ : Red, - : Black	+ : White, - : Black

*1 It is a holding brake for holding motors at standstill. It can not be used for dynamic braking.

*2 The value is for when a varistor, Zenamic Z15D151 or equivalent, is connected. No varistor is included with the 86 x 86 mm sq. sized motor.

Stepping Motors with Electromagnetic Brake 2-Phase

42 mm sq. **1.8° / step** RoHS Bipolar, Connector type

Model number	Holding torque at 2-phase excitation [N·m] or larger	Rated current A / phase	Wiring resistance Ω / phase	Winding inductance mH / phase	Rotor inertia × 10 ⁻⁴ kg · m ²	Mass kg	Motor length (L) mm
SF2421-10B41B	0.29	1	3.6	7	0.046	0.38	66.9
SF2422-10B41B	0.43	1	4.6	9.6	0.061	0.45	72.9
SF2423-10B41B	0.56	1	5.3	12.5	0.078	0.53	81.9
SF2424-10B41B	0.8	1	6.5	16	0.109	0.66	93.4

SF2421-10B41B

Constant current circuit
 Power supply voltage: 24 VDC
 Operating current: 1 A / phase
 At 2-phase excitation (full step)
 $J_r=0.94 \times 10^{-4} \text{kg} \cdot \text{m}^2$
 (when rubber coupling used)
 fs: Maximum starting rate when not loaded

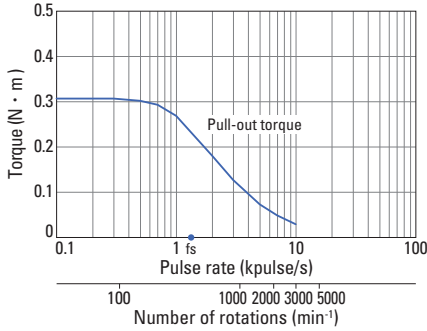

SF2422-10B41B

Constant current circuit
 Power supply voltage: 24 VDC
 Operating current: 1 A / phase
 At 2-phase excitation (full step)
 $J_r=0.94 \times 10^{-4} \text{kg} \cdot \text{m}^2$
 (when rubber coupling used)
 fs: Maximum starting rate when not loaded

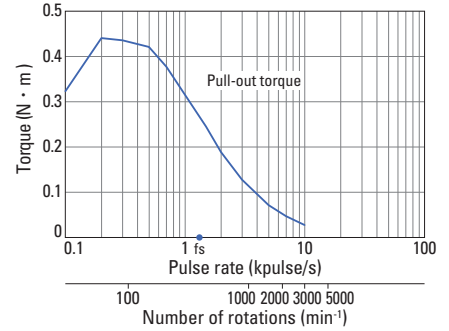

SF2423-10B41B

Constant current circuit
 Power supply voltage: 24 VDC
 Operating current: 1 A / phase
 At 2-phase excitation (full step)
 $J_r=0.94 \times 10^{-4} \text{kg} \cdot \text{m}^2$
 (when rubber coupling used)
 fs: Maximum starting rate when not loaded

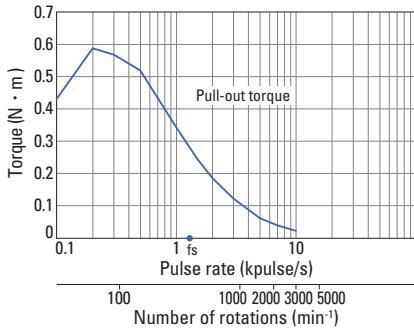

SF2424-10B41B

Constant current circuit
 Power supply voltage: 24 VDC
 Operating current: 1 A / phase
 At 2-phase excitation (full step)
 $J_r=2.6 \times 10^{-4} \text{kg} \cdot \text{m}^2$
 (when rubber coupling used)
 fs: Maximum starting rate when not loaded

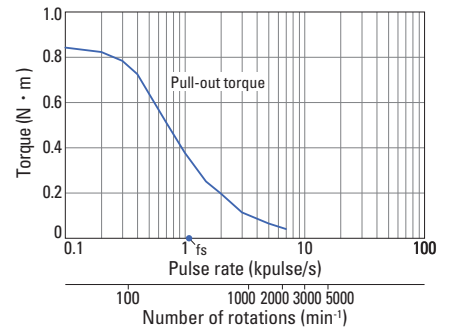

■ Dimensions [Unit: mm]

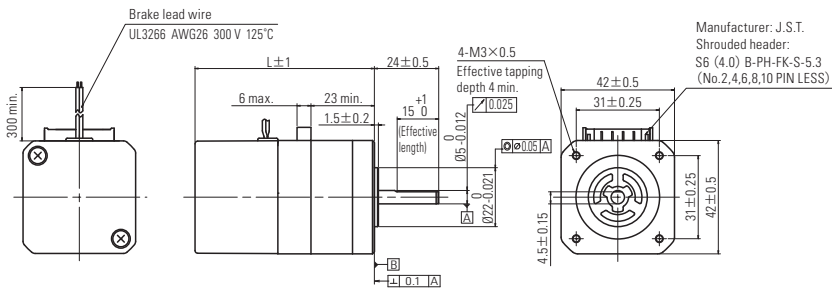

Option (sold separately): Motor cable model number. 4835775-1

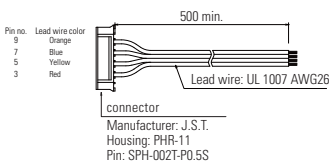

60 mm sq.

1.8° / step **RoHS** Bipolar, Connector type

Model number	Holding torque at 2-phase excitation [N·m] or larger	Rated current A / phase	Wiring resistance Ω / phase	Winding inductance mH / phase	Rotor inertia × 10 ⁻⁴ kg · m ²	Mass kg	Motor length (L) mm
Single shaft							
103H7821-57XB40	0.88	2	1.27	3.3	0.43	0.94	87.2
103H7822-57XB40	1.37	2	1.55	5.5	0.56	1.11	96.2
103H7823-57XB40	2.7	2	2.4	9.5	1	1.68	128.2

103H7821-57XB40

Constant current circuit
Power supply voltage: 24 VDC
Operating current: 2 A / phase
At 2-phase excitation (full step)
 $J_s=2.6 \times 10^{-4} \text{kg} \cdot \text{m}^2$
(when rubber coupling used)
fs: Maximum starting rate when not loaded

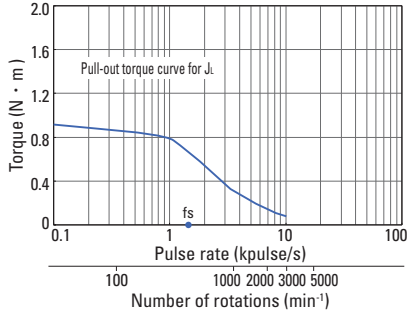

103H7822-57XB40

Constant current circuit
Power supply voltage: 24 VDC
Operating current: 2 A / phase
At 2-phase excitation (full step)
 $J_s=2.6 \times 10^{-4} \text{kg} \cdot \text{m}^2$
(when rubber coupling used)
fs: Maximum starting rate when not loaded

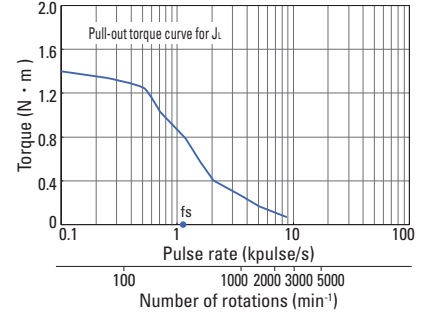

103H7823-57XB40

Constant current circuit
Power supply voltage: 24 VDC
Operating current: 2 A / phase
At 2-phase excitation (full step)
 $J_s=7.4 \times 10^{-4} \text{kg} \cdot \text{m}^2$
(when rubber coupling used)
fs: Maximum starting rate when not loaded

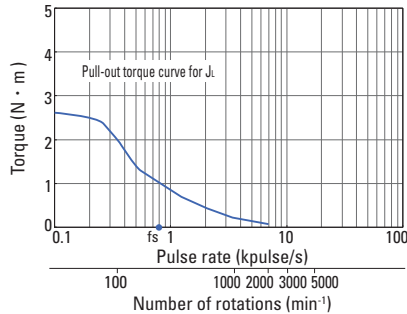

Dimensions [Unit: mm]

Option (sold separately): Motor cable model no. 4837961-1

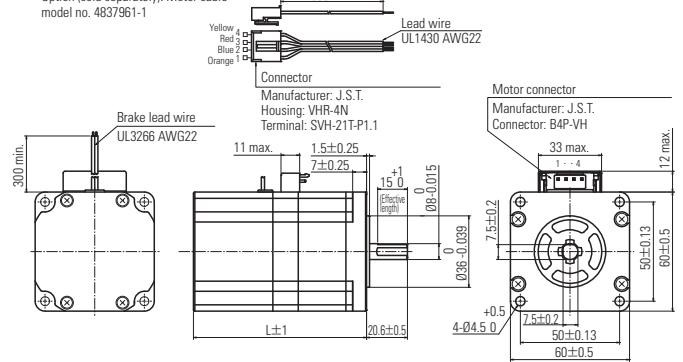

86 mm sq.

1.8° / step **RoHS** Bipolar, Cable type

Model number	Holding torque at 2-phase excitation [N·m] or larger	Rated current A / phase	Wiring resistance Ω / phase	Winding inductance mH / phase	Rotor inertia × 10 ⁻⁴ kg · m ²	Mass kg	Motor length (L) mm
SH2861-41XB41	3.3	4	0.58	3.7	2.55	2.6	119.5
SH2862-41XB41	6.4	4	0.85	6.4	4.07	3.75	150
SH2863-41XB41	9	4	1	7.9	5.57	4.85	180.4

SH2861-41XB41

Constant current circuit
Power supply voltage: 100 VAC
Operating current: 4 A / phase
At 2-phase excitation (full step)
 $J_s=15.3 \times 10^{-4} \text{kg} \cdot \text{m}^2$
(when rubber coupling used)
fs: Maximum starting rate when not loaded

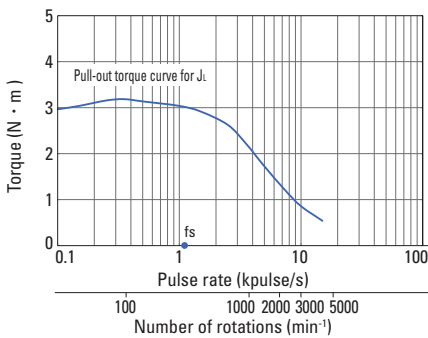

SH2862-41XB41

Constant current circuit
Power supply voltage: 100 VAC
Operating current: 4 A / phase
At 2-phase excitation (full step)
 $J_s=15.3 \times 10^{-4} \text{kg} \cdot \text{m}^2$
(when rubber coupling used)
fs: Maximum starting rate when not loaded

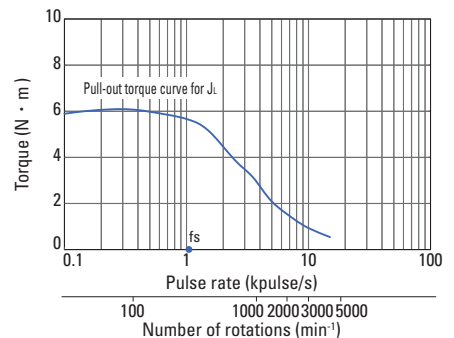

SH2863-41XB41

Constant current circuit
Power supply voltage: 100 VAC
Operating current: 4 A / phase
At 2-phase excitation (full step)
 $J_s=44 \times 10^{-4} \text{kg} \cdot \text{m}^2$
(when rubber coupling used)
fs: Maximum starting rate when not loaded

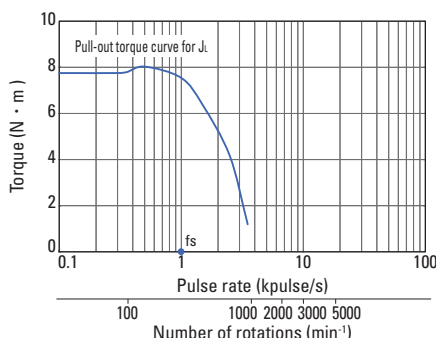

Dimensions [Unit: mm]

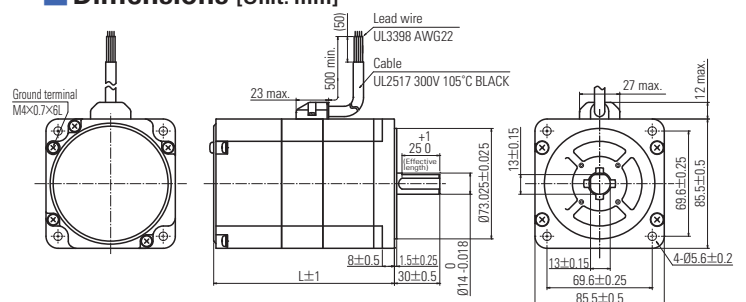

Stepping Motors with Gears

2-Phase



■ Features

High torque, High resolution, Low backlash

- Capable of driving larger loads compared with standard motors without gears.
- Steps can be finely divided with gears, enabling stable and high-precision positioning.

■ Lineup

42 mm sq., 60 mm sq., 86 mm sq.

42 mm sq.

Low-backlash gear model

Gear ratios	Units	1/3.6	1/7.2	1/10	1/20	1/30	1/36
Allowable torque	N · m	0.343	0.686	1	1.5	1.5	1.5
Allowable speed	min ⁻¹	500	250	180	90	60	50
Backlash	°	0.6	0.4	0.35	0.25	0.25	0.25
Rotational direction of the output shaft	Relative to the motor shaft rotational direction	Forward direction	Forward direction	Forward direction	Reverse direction	Reverse direction	Reverse direction
Allowable thrust load	N	15	15	15	15	15	15
Allowable radial load*	N	20	20	20	20	20	20

60 mm sq.

Low-backlash gear model

Gear ratios	Units	1/3.6	1/7.2	1/10	1/20	1/30	1/36
Allowable torque	N · m	1.25	2.5	3	3.5	4	4
Allowable speed	min ⁻¹	500	250	180	90	60	50
Backlash	°	0.55	0.25	0.25	0.17	0.17	0.17
Rotational direction of the output shaft	Relative to the motor shaft rotational direction	Forward direction	Forward direction	Reverse direction	Reverse direction	Reverse direction	Reverse direction
Allowable thrust load	N	30	30	30	30	30	30
Allowable radial load*	N	100	100	100	100	100	100

86 mm sq.

Low-backlash gear model (Flange size of gear part: 90 mm)

Gear ratios	Units	1/3.6	1/7.2	1/10	1/20	1/30	1/36
Allowable torque	N · m	4.5	9	9	12	12	12
Allowable speed	min ⁻¹	500	250	180	90	60	50
Backlash	°	0.35	0.22	0.22	0.15	0.15	0.15
Rotational direction of the output shaft	Relative to the motor shaft rotational direction	Forward direction	Forward direction	Reverse direction	Reverse direction	Reverse direction	Reverse direction
Allowable thrust load	N	60	60	60	60	60	60
Allowable radial load*	N	300	300	300	300	300	300

* When load is applied at 1/3 length from output shaft end.

Custom models can be made to meet various needs such as 28 mm size model, harmonic gear model, or planetary gear model. Contact us for details.

Stepping Motors General Specifications

Motor model number	SH228□	SF242□	103H712□	103H782□	SH286□
Type	—				
Operating ambient temperature	-10 to +50 °C (for ones with encoders, -10 to +40 °C)				
Storage temperature	-20 to +65 °C				
Operating ambient humidity	20 to 90% RH (no condensation)				
Storage humidity	5 to 95% RH (no condensation)				
Operating altitude	1000 m max. above sea level				
Vibration resistance	Vibration frequency 10 to 500 Hz, total amplitude 1.52 mm (10 to 70 Hz), vibration acceleration 150 m/s ² (70 to 500 Hz), sweep time 15 min/cycle, 12 sweeps in each X, Y and Z direction.				
Impact resistance	500 m/s ² of acceleration for 11 ms with half-sine wave applying three times for X, Y, and Z axes each, 18 times in total.				
Thermal class	Class B (+130 °C)				
Dielectric strength	At normal temperature and humidity, no failure with 500 VAC at 50/60 Hz applied for one minute between motor winding and frame.			At normal temperature and humidity, no failure with 1000 VAC at 50/60 Hz applied for one minute between motor winding and frame.	
Insulation resistance	At normal temperature and humidity, not less than 100 MΩ between winding and frame by 500 VDC megger.				
Protection grade	—				
Winding temperature rise	80 K max. (based on SANYO DENKI's standard measurement conditions.)				
Positional accuracy	± 0.09°		± 0.054°	± 0.09°	
Thrust play ¹	0.075 mm max. (load: 1.5 N)	0.075 mm max. (load: 5 N)	0.075 mm max. (load: 10 N)		
Radial play ²	0.025 mm max. (load: 5 N)				
Shaft runout	0.025 mm				
Concentricity of mounting pilot relative to shaft	φ 0.05 mm		φ 0.075 mm		
Perpendicularity of mounting surface relative to shaft	0.1 mm		0.075 mm		0.15 mm
Motor mounting orientation	Can be freely mounted vertically or horizontally				

*1 Displacement in shaft position in the axial direction when a load is applied to the motor shaft in the axial direction.

*2 Displacement in shaft position in the radial direction when a load is applied in the vertical direction to the mounting surface of shaft at point 1/3 the shaft length from the end of the motor shaft.

Internal wiring and rotation direction

Bipolar winding

Connector type model no.: SF242 □

Internal wire connection

() connector pin number

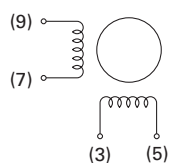

Direction of motor rotation

When excited by a direct current in the order shown below, the direction of rotation is clockwise as viewed from the output shaft side.

		Connector pin no.			
		(3)	(7)	(5)	(9)
Exciting order	1	—	—	+	+
	2	+	—	—	+
	3	+	+	—	—
	4	—	+	+	—

Connector type model no.: 103H782 □

Internal wire connection

() connector pin number

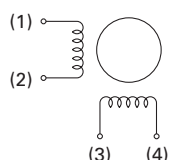

Direction of motor rotation

When excited by a direct current in the order shown below, the direction of rotation is clockwise as viewed from the output shaft side.

		Connector pin no.			
		(3)	(2)	(4)	(1)
Exciting order	1	—	—	+	+
	2	+	—	—	+
	3	+	+	—	—
	4	—	+	+	—

Lead wire type

Internal wire connection

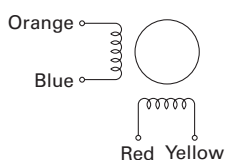

Direction of motor rotation

When excited by a direct current in the order shown below, the direction of rotation is clockwise as viewed from the output shaft side.

		Lead wire color			
		Red	Blue	Yellow	Orange
Exciting order	1	—	—	+	+
	2	+	—	—	+
	3	+	+	—	—
	4	—	+	+	—



Notes before Purchase

The products in this catalog are designed to be used with general industrial devices.

Always follow the following precautions.

- Read the accompanying Instruction Manual carefully prior to using the product.
- If applying to medical devices and other equipment affecting people's lives, please contact us beforehand and take appropriate safety measures.
- If applying to equipment that can have significant effects on society and the general public, please contact us beforehand.
- Do not use this product in an environment where vibration is present, such as in a moving vehicle or shipping vessel.
- Do not perform any retrofitting, re-engineering, or modification to this equipment.
- The products presented in this catalog are meant to be used for general industrial applications. If using for special applications related to aviation and space, nuclear power, electric power, submarine repeaters, and the like, please contact us beforehand.

SANYO DENKI CO., LTD. 3-33-1 Minami-Otsuka, Toshima-ku, Tokyo 170-8451, Japan TEL: +81 3 5927 1020

<https://www.sanyodenki.com>

The names of companies and/or their products specified in this catalog are the trade names, and/or trademarks and/or registered trademarks of such respective companies.

SANMOTION is a trademark of SANYO DENKI CO., LTD.

Specifications are subject to change without notice.

CATALOG No. S1035B002 '21.1