

# SANMOTION

2-PHASE STEPPING SYSTEMS

# F2

## 56 mm sq. 2-Phase Stepping Motors

DC Input

UL<sup>®</sup> US



Flange size: 56 mm

Motor length (motor only): 41.8, 53.8, 75.8, 85.8 mm

Unipolar winding / Bipolar winding

Single shaft / Dual shaft

Stepping motors / Geared / With electromagnetic brake / With encoder

### High torque

Compared to our conventional model, torque performance has improved by approximately 40%.\*  
This contributes to shortening the positioning time and machine cycle time.

### Low noise

These motors have noise levels approximately 3 dB lower than the current model, reducing the noise level of machines.\*

### Energy-saving

Motor efficiency has been improved by approximately 3% compared to the current model.\*  
This contributes to reducing power consumption of machines and the motor's heat dissipation.

\* A comparison between our current model 103H7123-5840 and new model SM2562C30B41.



**DISAI**  
Automatic Systems

**SANYO DENKI**

T: 962 448 450 [www.disai.net](http://www.disai.net)

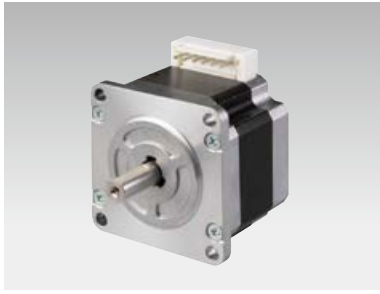

# 56 mm sq.

1.8°/step RoHS

Unipolar winding, connector type



Lineup → p. 7

Low-backlash gear model

Harmonic gear model

Electromagnetic brake model

Encoder model

## Unipolar winding, connector type

Model no.		Holding torque at 2-phase excitation N·m min.	Rated current A/phase	Wiring resistance Ω/phase	Winding inductance mH/phase	Rotor inertia ×10 <sup>-4</sup> kg·m <sup>2</sup>	Mass kg	Motor length (L) mm
Single shaft	Dual shaft							
SM2561C10U41	SM2561C10U11	0.53	1	4.3	6.8	0.14	0.49	41.8
SM2561C20U41	SM2561C20U11	0.53	2	1.15	1.8	0.14	0.49	41.8
SM2561C30U41	SM2561C30U11	0.53	3	0.52	0.77	0.14	0.49	41.8
SM2562C10U41	SM2562C10U11	1.1	1	5.85	12.6	0.28	0.69	53.8
SM2562C20U41	SM2562C20U11	1.1	2	1.55	3.3	0.28	0.69	53.8
SM2562C30U41	SM2562C30U11	1.1	3	0.69	1.37	0.28	0.69	53.8
SM2563C10U41	SM2563C10U11	1.7	1	7.8	17	0.5	1.1	75.8
SM2563C20U41	SM2563C20U11	1.7	2	1.87	4.2	0.5	1.1	75.8
SM2563C30U41	SM2563C30U11	1.7	3	0.74	1.75	0.5	1.1	75.8
SM2564C10U41	SM2564C10U11	1.75	1	9	22	0.6	1.27	85.8
SM2564C20U41	SM2564C20U11	1.75	2	2.1	5.4	0.6	1.27	85.8
SM2564C30U41	SM2564C30U11	1.75	3	0.84	2.2	0.6	1.27	85.8

Motor cable: model no. 4837798-1

## Characteristics diagram

### SM2561C10U41 SM2561C10U11

Constant current circuit  
Source voltage: 24 VDC  
Operating current:  
1 A/phase, 2-phase  
excitation (full-step)  
Pull-out torque:  
 $J_L=0.94 \times 10^{-4}$ kg·m<sup>2</sup> (with  
rubber coupling)  
fs: Maximum self-start  
frequency when not  
loaded

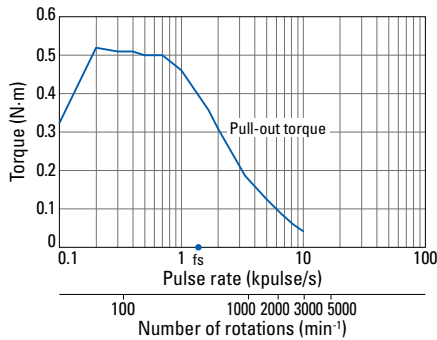

### SM2561C20U41 SM2561C20U11

Constant current circuit  
Source voltage: 24 VDC  
Operating current:  
2 A/phase, 2-phase  
excitation (full-step)  
Pull-out torque:  
 $J_L=0.94 \times 10^{-4}$ kg·m<sup>2</sup> (with  
rubber coupling)  
fs: Maximum self-start  
frequency when not  
loaded

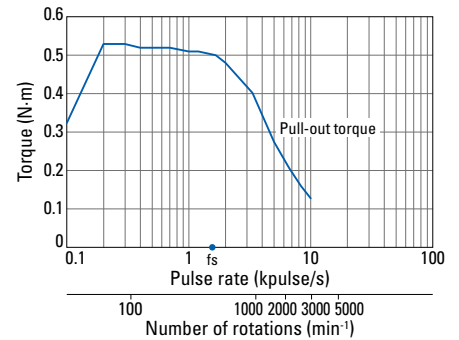

### SM2561C30U41 SM2561C30U11

Constant current circuit  
Source voltage: 24 VDC  
Operating current:  
3 A/phase, 2-phase  
excitation (full-step)  
Pull-out torque:  
 $J_L=0.94 \times 10^{-4}$ kg·m<sup>2</sup> (with  
rubber coupling)  
fs: Maximum self-start  
frequency when not  
loaded

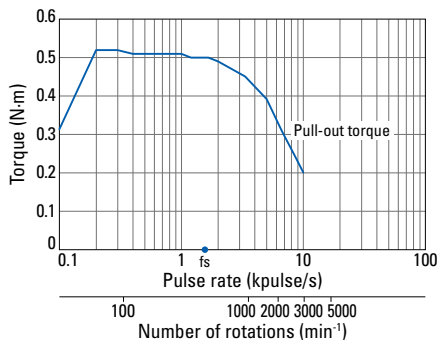

### SM2562C10U41 SM2562C10U11

Constant current circuit  
Source voltage: 24 VDC  
Operating current:  
1 A/phase, 2-phase  
excitation (full-step)  
Pull-out torque:  
 $J_L=2.6 \times 10^{-4}$ kg·m<sup>2</sup> (with  
rubber coupling)  
fs: Maximum self-start  
frequency when not  
loaded

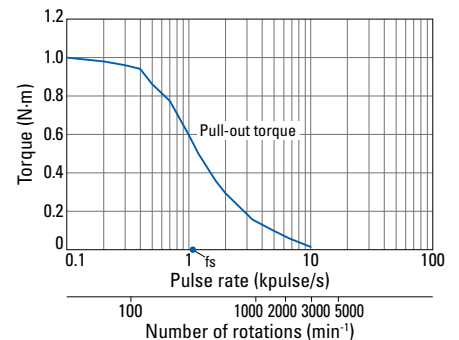

### SM2562C20U41 SM2562C20U11

Constant current circuit  
Source voltage: 24 VDC  
Operating current:  
2 A/phase, 2-phase  
excitation (full-step)  
Pull-out torque:  
 $J_L=2.6 \times 10^{-4}$ kg·m<sup>2</sup> (with  
rubber coupling)  
fs: Maximum self-start  
frequency when not  
loaded

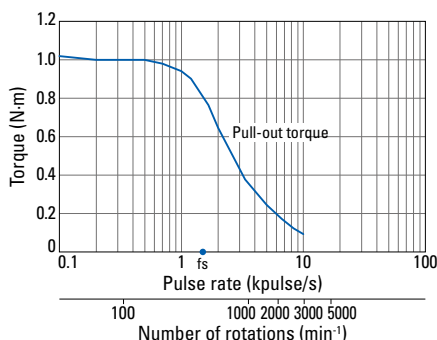

### SM2562C30U41 SM2562C30U11

Constant current circuit  
Source voltage: 24 VDC  
Operating current:  
3 A/phase, 2-phase  
excitation (full-step)  
Pull-out torque:  
 $J_L=2.6 \times 10^{-4}$ kg·m<sup>2</sup> (with  
rubber coupling)  
fs: Maximum self-start  
frequency when not  
loaded

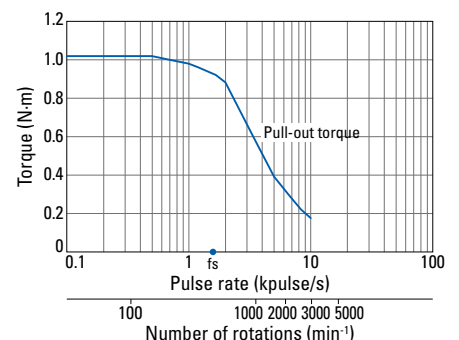

## Characteristics diagram

### SM2563C10U41 SM2563C10U11

Constant current circuit  
Source voltage: 24 VDC  
Operating current:  
1 A/phase, 2-phase  
excitation (full-step)  
Pull-out torque:  
 $J_L=7.4 \times 10^{-4} \text{kg}\cdot\text{m}^2$  (with  
rubber coupling)  
fs: Maximum self-start  
frequency when not  
loaded

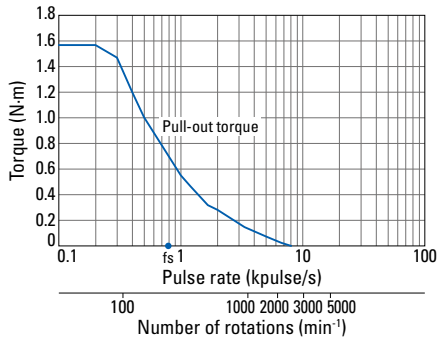

### SM2563C20U41 SM2563C20U11

Constant current circuit  
Source voltage: 24 VDC  
Operating current:  
2 A/phase, 2-phase  
excitation (full-step)  
Pull-out torque:  
 $J_L=7.4 \times 10^{-4} \text{kg}\cdot\text{m}^2$  (with  
rubber coupling)  
fs: Maximum self-start  
frequency when not  
loaded

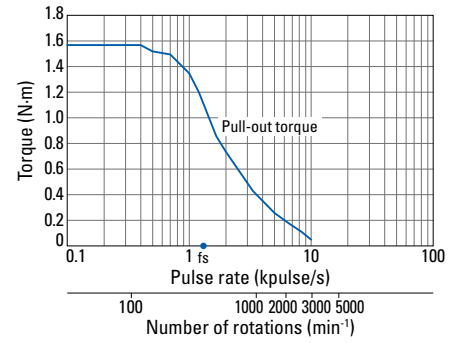

### SM2563C30U41 SM2563C30U11

Constant current circuit  
Source voltage: 24 VDC  
Operating current:  
3 A/phase, 2-phase  
excitation (full-step)  
Pull-out torque:  
 $J_L=7.4 \times 10^{-4} \text{kg}\cdot\text{m}^2$  (with  
rubber coupling)  
fs: Maximum self-start  
frequency when not  
loaded

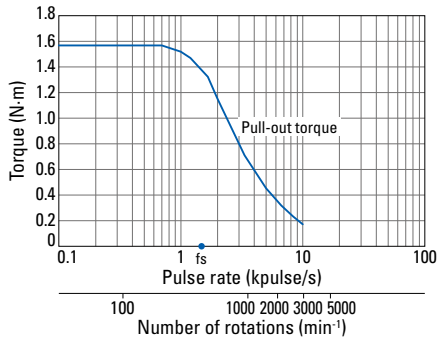

### SM2564C10U41 SM2564C10U11

Constant current circuit  
Source voltage: 24 VDC  
Operating current:  
1 A/phase, 2-phase  
excitation (full-step)  
Pull-out torque:  
 $J_L=7.4 \times 10^{-4} \text{kg}\cdot\text{m}^2$  (with  
rubber coupling)  
fs: Maximum self-start  
frequency when not  
loaded

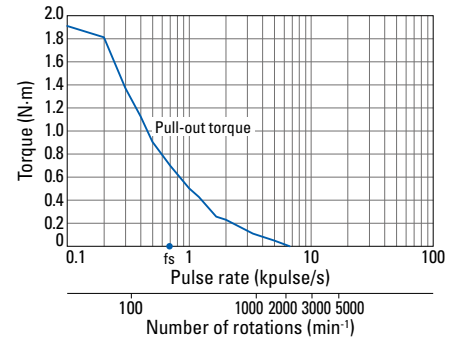

### SM2564C20U41 SM2564C20U11

Constant current circuit  
Source voltage: 24 VDC  
Operating current:  
2 A/phase, 2-phase  
excitation (full-step)  
Pull-out torque:  
 $J_L=7.4 \times 10^{-4} \text{kg}\cdot\text{m}^2$  (with  
rubber coupling)  
fs: Maximum self-start  
frequency when not  
loaded

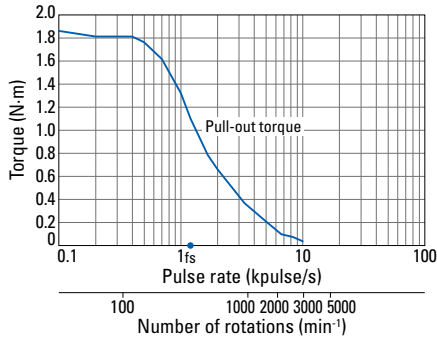

### SM2564C30U41 SM2564C30U11

Constant current circuit  
Source voltage: 24 VDC  
Operating current:  
3 A/phase, 2-phase  
excitation (full-step)  
Pull-out torque:  
 $J_L=7.4 \times 10^{-4} \text{kg}\cdot\text{m}^2$  (with  
rubber coupling)  
fs: Maximum self-start  
frequency when not  
loaded

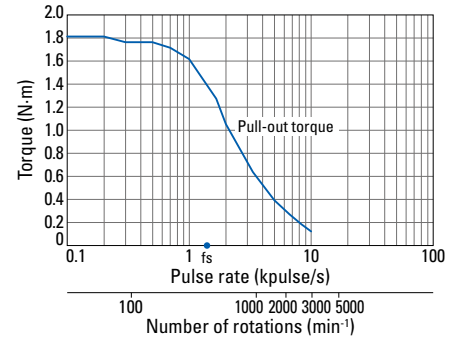

## Dimensions (Unit: mm)

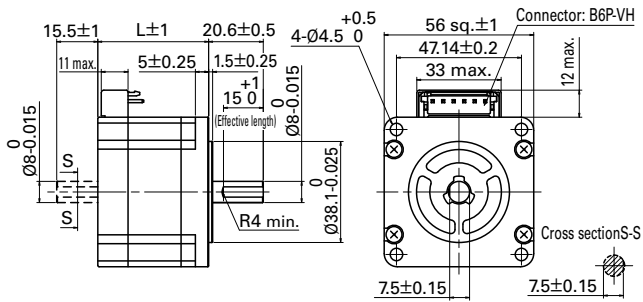

Option (sold separately): Unipolar motor cable 4837798-1

Manufacturer: J.S.T.  
Housing: VHR-6N  
Pin: SVH-21T-P1.1

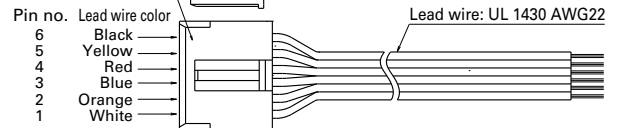

## Internal wiring ( ) connector pin number

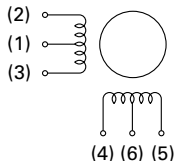

## Compatible drivers

- For motors with model nos. SM256□C20U□1 (2 A/phase)  
Model no.: US1D200P10 (DC input)  
Operating current selection switch setting: 0
  - For motors other than the above.  
We do not offer compatible drivers available.  
If you require assistance finding a driver, contact us.
- Note: The motor characteristics shown above use our experimental circuit.*



# 56 mm sq.

1.8°/step RoHS

Bipolar winding, connector type



Lineup → p. 7

Low-backlash gear model

Harmonic gear model

Electromagnetic brake model

Encoder model

## Bipolar winding, connector type

Model no.		Holding torque at 2-phase excitation N·m min.	Rated current A/phase	Wiring resistance Ω/phase	Winding inductance mH/phase	Rotor inertia ×10 <sup>-4</sup> kg·m <sup>2</sup>	Mass kg	Motor length (L) mm
Single shaft	Dual shaft							
SM2561C10B41	SM2561C10B11	0.75	1	4.6	13.5	0.14	0.49	41.8
SM2561C20B41	SM2561C20B11	0.75	2	1.1	3.5	0.14	0.49	41.8
SM2561C30B41	SM2561C30B11	0.75	3	0.51	1.5	0.14	0.49	41.8
SM2561C40B41	SM2561C40B11	0.75	4	0.28	0.85	0.14	0.49	41.8
SM2561C60B41	SM2561C60B11	0.75	6	0.14	0.38	0.14	0.49	41.8
SM2562C10B41	SM2562C10B11	1.4	1	6.3	25.5	0.28	0.69	53.8
SM2562C20B41	SM2562C20B11	1.4	2	1.5	6.5	0.28	0.69	53.8
SM2562C30B41	SM2562C30B11	1.4	3	0.68	2.9	0.28	0.69	53.8
SM2562C40B41	SM2562C40B11	1.4	4	0.37	1.5	0.28	0.69	53.8
SM2562C60B41	SM2562C60B11	1.4	6	0.18	0.72	0.28	0.69	53.8
SM2563C10B41	SM2563C10B11	2.35	1	8.6	36	0.5	1.1	75.8
SM2563C20B41	SM2563C20B11	2.35	2	2.1	9.5	0.5	1.1	75.8
SM2563C30B41	SM2563C30B11	2.35	3	0.95	4.2	0.5	1.1	75.8
SM2563C40B41	SM2563C40B11	2.35	4	0.52	2.4	0.5	1.1	75.8
SM2563C60B41	SM2563C60B11	2.35	6	0.25	1.05	0.5	1.1	75.8
SM2564C10B41	SM2564C10B11	2.5	1	9.4	41	0.6	1.27	85.8
SM2564C20B41	SM2564C20B11	2.5	2	2.1	11	0.6	1.27	85.8
SM2564C30B41	SM2564C30B11	2.5	3	0.95	4.9	0.6	1.27	85.8
SM2564C40B41	SM2564C40B11	2.5	4	0.59	2.8	0.6	1.27	85.8
SM2564C60B41	SM2564C60B11	2.5	6	0.27	1.15	0.6	1.27	85.8

Motor cable: model no. 4837961-1

## Characteristics diagram

### SM2561C10B41 SM2561C10B11

Constant current circuit  
Source voltage: 24 VDC  
Operating current:  
1 A/phase, 2-phase  
excitation (full-step)  
Pull-out torque:  
 $J_L=0.94 \times 10^{-4}$ kg·m<sup>2</sup> (with  
rubber coupling)  
fs: Maximum self-start  
frequency when not  
loaded

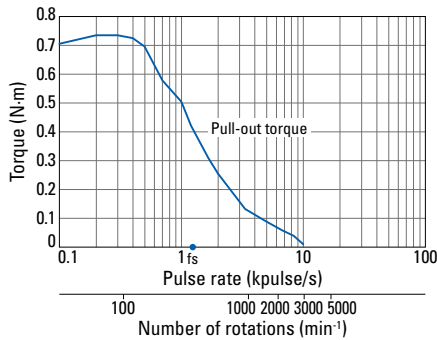

### SM2561C20B41 SM2561C20B11

Constant current circuit  
Source voltage: 24 VDC  
Operating current:  
2 A/phase, 2-phase  
excitation (full-step)  
Pull-out torque:  
 $J_L=0.94 \times 10^{-4}$ kg·m<sup>2</sup> (with  
rubber coupling)  
fs: Maximum self-start  
frequency when not  
loaded

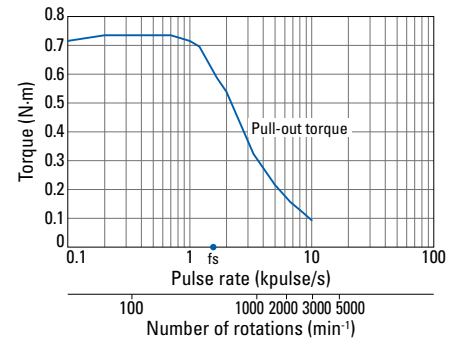

### SM2561C30B41 SM2561C30B11

Constant current circuit  
Source voltage: 24 VDC  
Operating current:  
3 A/phase, 2-phase  
excitation (full-step)  
Pull-out torque:  
 $J_L=0.94 \times 10^{-4}$ kg·m<sup>2</sup> (with  
rubber coupling)  
fs: Maximum self-start  
frequency when not  
loaded

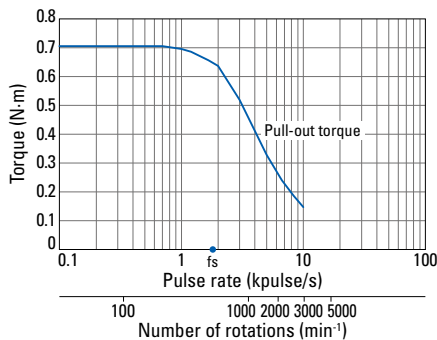

### SM2561C40B41 SM2561C40B11

Constant current circuit  
Source voltage: 24 VDC  
Operating current:  
4 A/phase, 2-phase  
excitation (full-step)  
Pull-out torque:  
 $J_L=0.94 \times 10^{-4}$ kg·m<sup>2</sup> (with  
rubber coupling)  
fs: Maximum self-start  
frequency when not  
loaded

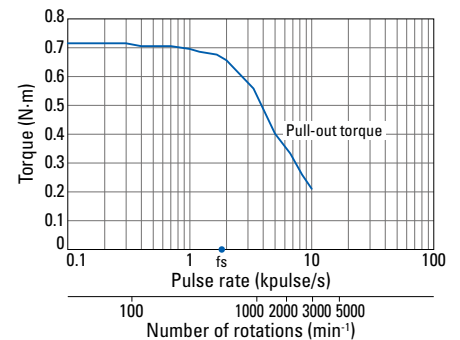

## Characteristics diagram

### SM2561C60B41 SM2561C60B11

Constant current circuit  
Source voltage: 24 VDC  
Operating current:  
6 A/phase, 2-phase  
excitation (full-step)  
Pull-out torque:  
 $J_L=0.94 \times 10^{-4} \text{kg}\cdot\text{m}^2$  (with  
rubber coupling)  
 $f_s$ : Maximum self-start  
frequency when not  
loaded

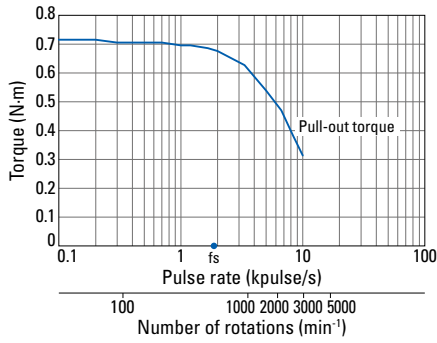

### SM2562C10B41 SM2562C10B11

Constant current circuit  
Source voltage: 24 VDC  
Operating current:  
1 A/phase, 2-phase  
excitation (full-step)  
Pull-out torque:  
 $J_L=2.6 \times 10^{-4} \text{kg}\cdot\text{m}^2$  (with  
 $f_s$ : Maximum self-start  
frequency when not  
loaded

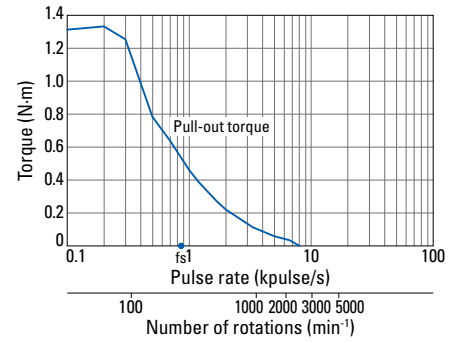

### SM2562C20B41 SM2562C20B11

Constant current circuit  
Source voltage: 24 VDC  
Operating current:  
2 A/phase, 2-phase  
excitation (full-step)  
Pull-out torque:  
 $J_L=2.6 \times 10^{-4} \text{kg}\cdot\text{m}^2$  (with  
rubber coupling)  
 $f_s$ : Maximum self-start  
frequency when not  
loaded

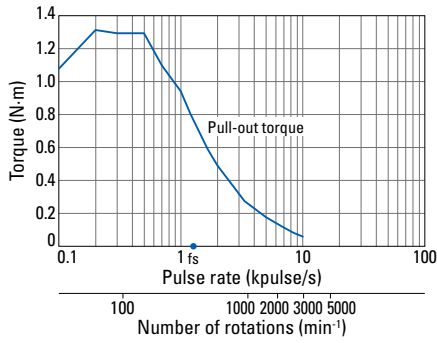

### SM2562C30B41 SM2562C30B11

Constant current circuit  
Source voltage: 24 VDC  
Operating current:  
3 A/phase, 2-phase  
excitation (full-step)  
Pull-out torque:  
 $J_L=2.6 \times 10^{-4} \text{kg}\cdot\text{m}^2$  (with  
rubber coupling)  
 $f_s$ : Maximum self-start  
frequency when not  
loaded

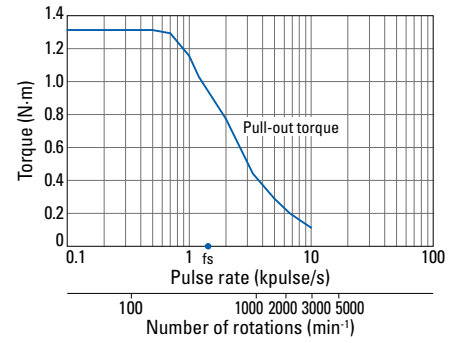

### SM2562C40B41 SM2562C40B11

Constant current circuit  
Source voltage: 24 VDC  
Operating current:  
4 A/phase, 2-phase  
excitation (full-step)  
Pull-out torque:  
 $J_L=2.6 \times 10^{-4} \text{kg}\cdot\text{m}^2$  (with  
rubber coupling)  
 $f_s$ : Maximum self-start  
frequency when not  
loaded

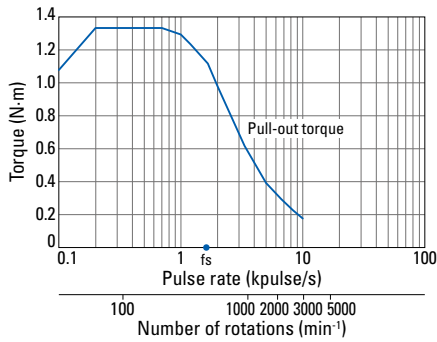

### SM2562C60B41 SM2562C60B11

Constant current circuit  
Source voltage: 24 VDC  
Operating current:  
6 A/phase, 2-phase  
excitation (full-step)  
Pull-out torque:  
 $J_L=2.6 \times 10^{-4} \text{kg}\cdot\text{m}^2$  (with  
rubber coupling)  
 $f_s$ : Maximum self-start  
frequency when not  
loaded

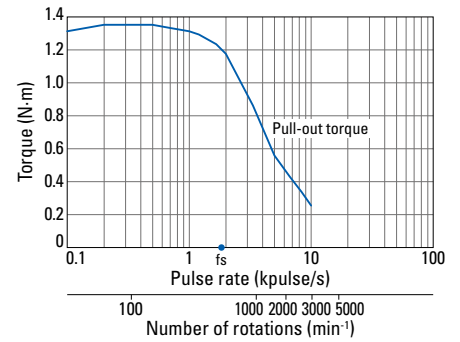

### SM2563C10B41 SM2563C10B11

Constant current circuit  
Source voltage: 24 VDC  
Operating current:  
1 A/phase, 2-phase  
excitation (full-step)  
Pull-out torque:  
 $J_L=7.4 \times 10^{-4} \text{kg}\cdot\text{m}^2$  (with  
rubber coupling)  
 $f_s$ : Maximum self-start  
frequency when not  
loaded

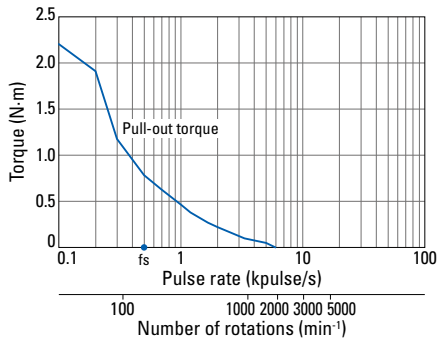

### SM2563C20B41 SM2563C20B11

Constant current circuit  
Source voltage: 24 VDC  
Operating current:  
2 A/phase, 2-phase  
excitation (full-step)  
Pull-out torque:  
 $J_L=7.4 \times 10^{-4} \text{kg}\cdot\text{m}^2$  (with  
rubber coupling)  
 $f_s$ : Maximum self-start  
frequency when not  
loaded

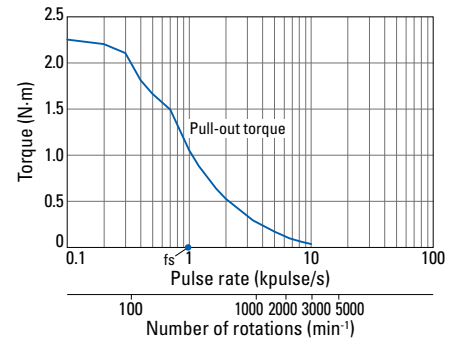

### SM2563C30B41 SM2563C30B11

Constant current circuit  
Source voltage: 24 VDC  
Operating current:  
3 A/phase, 2-phase  
excitation (full-step)  
Pull-out torque:  
 $J_L=7.4 \times 10^{-4} \text{kg}\cdot\text{m}^2$  (with  
rubber coupling)  
 $f_s$ : Maximum self-start  
frequency when not  
loaded

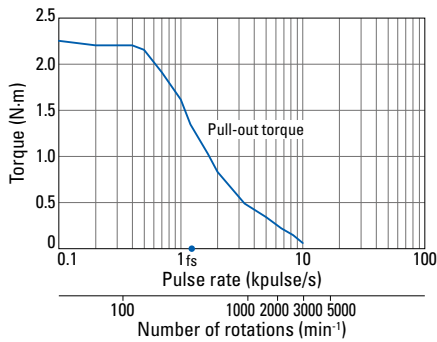

### SM2563C40B41 SM2563C40B11

Constant current circuit  
Source voltage: 24 VDC  
Operating current:  
4 A/phase, 2-phase  
excitation (full-step)  
Pull-out torque:  
 $J_L=7.4 \times 10^{-4} \text{kg}\cdot\text{m}^2$  (with  
rubber coupling)  
 $f_s$ : Maximum self-start  
frequency when not  
loaded

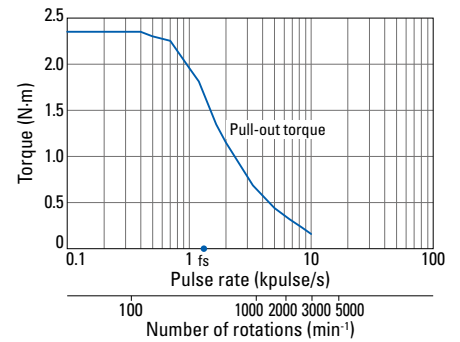

## Characteristics diagram

### SM2563C60B41 SM2563C60B11

Constant current circuit  
Source voltage: 24 VDC  
Operating current:  
6 A/phase, 2-phase  
excitation (full-step)  
Pull-out torque:  
 $J_L=7.4 \times 10^{-4} \text{kg}\cdot\text{m}^2$  (with  
rubber coupling)  
fs: Maximum self-start  
frequency when not  
loaded

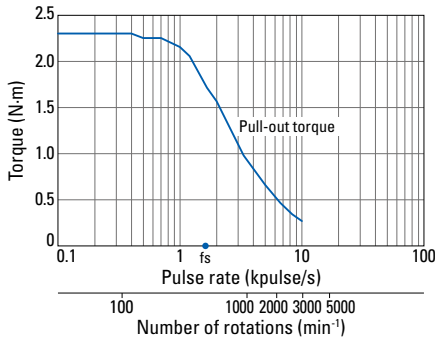

### SM2564C10B41 SM2564C10B11

Constant current circuit  
Source voltage: 24 VDC  
Operating current:  
1 A/phase, 2-phase  
excitation (full-step)  
Pull-out torque:  
 $J_L=7.4 \times 10^{-4} \text{kg}\cdot\text{m}^2$  (with  
rubber coupling)  
fs: Maximum self-start  
frequency when not  
loaded

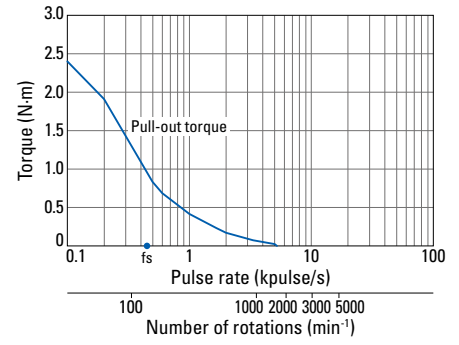

### SM2564C20B41 SM2564C20B11

Constant current circuit  
Source voltage: 24 VDC  
Operating current:  
2 A/phase, 2-phase  
excitation (full-step)  
Pull-out torque:  
 $J_L=7.4 \times 10^{-4} \text{kg}\cdot\text{m}^2$  (with  
rubber coupling)  
fs: Maximum self-start  
frequency when not  
loaded

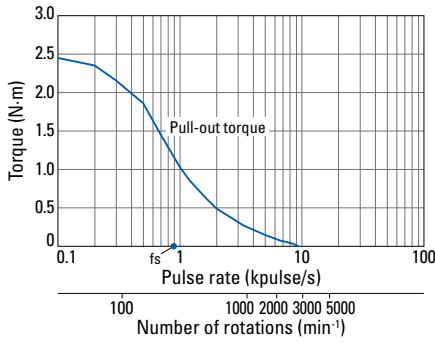

### SM2564C30B41 SM2564C30B11

Constant current circuit  
Source voltage: 24 VDC  
Operating current:  
3 A/phase, 2-phase  
excitation (full-step)  
Pull-out torque:  
 $J_L=7.4 \times 10^{-4} \text{kg}\cdot\text{m}^2$  (with  
fs: Maximum self-start  
frequency when not  
loaded

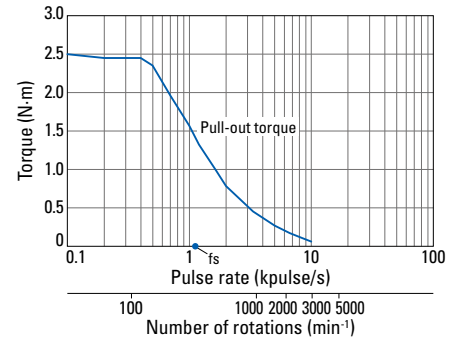

### SM2564C40B41 SM2564C40B11

Constant current circuit  
Source voltage: 24 VDC  
Operating current:  
4 A/phase, 2-phase  
excitation (full-step)  
Pull-out torque:  
 $J_L=7.4 \times 10^{-4} \text{kg}\cdot\text{m}^2$  (with  
rubber coupling)  
fs: Maximum self-start  
frequency when not  
loaded

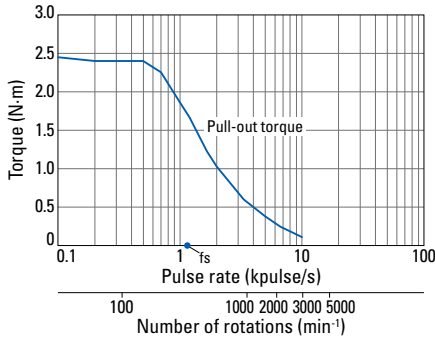

### SM2564C60B41 SM2564C60B11

Constant current circuit  
Source voltage: 24 VDC  
Operating current:  
6 A/phase, 2-phase  
excitation (full-step)  
Pull-out torque:  
 $J_L=7.4 \times 10^{-4} \text{kg}\cdot\text{m}^2$  (with  
rubber coupling)  
fs: Maximum self-start  
frequency when not  
loaded

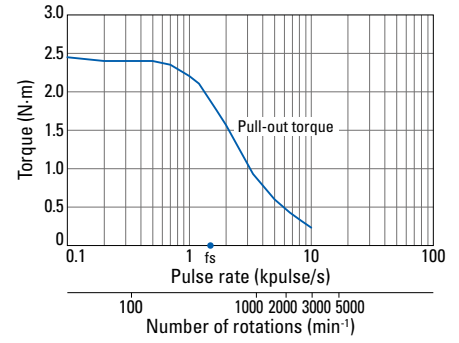

## Dimensions (Unit: mm)

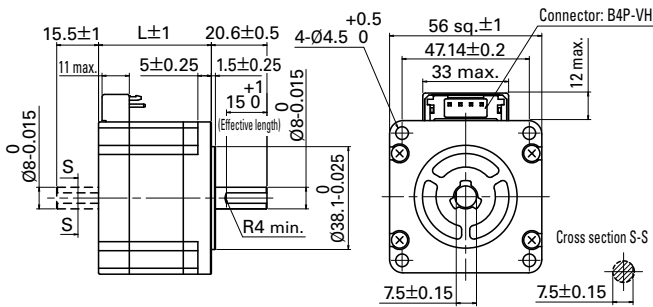

### Bipolar motor cable 4837961-1

Manufacturer: J.S.T.  
Housing: VHR-4N  
Pin: SVH-21T-P1.1

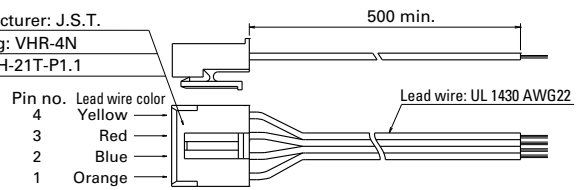

## Internal wiring ( ) connector pin number

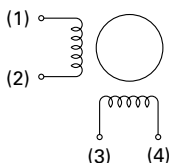

## Compatible drivers

- For motors with model nos. SM256 □ C20B □ 1 (2 A/phase)  
Model no.: BS1D200P10 (DC input)  
Operating current selection switch setting: 0
- For motors other than the above.  
We do not offer compatible drivers available.  
If you require assistance finding a driver, contact us.  
*Note: The motor characteristics shown above use our experimental circuit.*

# Rich motor lineup available for various needs

## Geared models

Applicable models: S□2561

### Low-backlash gear model

This model features low-backlash gear.

Allowable torque	N·m	1.25	2.5	3	3.5	4	4
Gear ratio	—	1:3.6	1:7.2	1:10	1:20	1:30	1:36
Backlash	° max.	0.55	0.25	0.25	0.17	0.17	0.17
Allowable speed	min <sup>-1</sup>	500	250	180	90	60	50
Allowable thrust load	N	30	30	30	30	30	30
Allowable radial load <sup>(1)</sup>	N	100	100	100	100	100	100

(1) When load is applied at 1/3 length from output shaft end.

· Directions of motor rotation and gear output shaft rotation are the same for models with gear ratios 1:3.6 and 1:7.2, and opposite for gear ratios 1:10, 1:20, 1:30, and 1:36.

### Harmonic gear model

This model has extremely low backlash and superb positioning precision. The lineup has high gear ratios of up to 1:100 available.

Allowable torque	N·m	5.5	8
Allowable peak torque	N·m	14	20
Gear ratio	—	1:50	1:100
Lost motion	Arc min	0.4 to 3 (at ±0.28 N·m)	0.4 to 1.5 (at ±0.4 N·m)
Allowable speed	min <sup>-1</sup>	70	35
Allowable peak speed	min <sup>-1</sup>	100	50
Allowable thrust load	N	400	400
Allowable radial load <sup>(2)</sup>	N	360	360

(2) When load is applied at 1/3 length from output shaft end.

The motor shaft and the gear output shaft rotate in the opposite directions.



## Electromagnetic brake model

Applicable models: All models listed in this catalog

The non-excitation electromagnetic brake holds a workpiece when power is lost, preventing it from falling.

Brake type	—	Non-excitation actuation type
Power supply voltage	—	24 VDC±5%
Power consumption	W	6 (at 75°C)
Static friction torque	N·m min.	0.8
Polarity	—	Red: +, Black: -



## Encoder models

Applicable models: All models listed in this catalog

This model can detect vibration and step-out by monitoring the motor's operation status such as position and speed.

Resolution	P/R	1000	2000	4000
Number of channels	CH	3	3	3
Output method	—	Line driver (CMOS)		
Max. response frequency	kHz	55	110	220
Power supply voltage	—	5 V±5%	5 V±5%	5 V±5%
Current consumption	mA max.	100	100	100

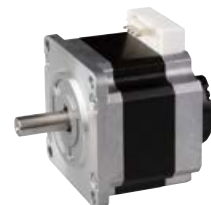



### Notes before Purchase

The products in this catalog are designed to be used with general industrial devices.

Always follow the following precautions.

- Read the accompanying Instruction Manual carefully prior to using the product.
- If applying to medical devices and other equipment affecting people's lives, please contact us beforehand and take appropriate safety measures.
- If applying to equipment that can have significant effects on society and the general public, please contact us beforehand.

· Do not use this product in an environment where vibration is present, such as in a moving vehicle or shipping vessel.

· Do not perform any retrofitting, re-engineering, or modification to this equipment.

· The products presented in this catalog are meant to be used for general industrial applications. If using for special applications related to aviation and space, nuclear power, electric power, submarine repeaters, and the like, please contact us beforehand.

**SANYO DENKI CO., LTD.** 3-33-1 Minami-Otsuka, Toshima-ku, Tokyo 170-8451, Japan TEL: +81 3 5927 1020

<https://www.sanyodenki.com/>

The names of companies and/or their products specified in this catalog are the trade names, and/or trademarks and/or registered trademarks of such respective companies.

SANMOTION is a trademark of SANYO DENKI CO., LTD.

Specifications are subject to change without notice.

CATALOG No.S1056B001 '21.5