

STEPPING MOTOR DRIVES



STEPPING MOTOR DRIVES



INDEX

EtherCAT	49
CANopen	67
MODBUS TCP	71
STEP/DIRECTION ADVANCED	75
PROGRAMMABLE	97
ANALOG INPUT	107
ACCESSORIES - SWITCHING POWER SUPPLIES	111

6 Drives families, nearly 100 different models

EtherCAT®

CANopen®

Modbus
TCP/IP



Key advantages of R.T.A. stepper drives

- Wide range of operating protocols: Step/Dir, Analog, RS485, EtherCAT, ModBus TCP, CAN Open.
- Tuneless Closed-Loop and Auto-Synchronization functions for EtherCAT and ModBus drives.
- 110-230Vac Direct Voltage Bus technology for top speed/torque performances up to 3,000 rpm.
- Widest power range on market: 200+ models from 24 Vdc to 230 Vac - from 0.1A to 10A.
- Modular, stand-alone and combo units.
- Simplicity by Design: immediate installation setup and easy maintenance.
- Defect-free guaranteed at delivery: double individual test for all models prior to shipment.
- 100% Made in Italy: Design, Production, Assembling, Testing.

R.T.A. Customer is never left alone

- Pre-sales sizing/selection service.
- Multilanguage post-sales hardware & software technical staff.
- Products availability and support guaranteed for 20 years after installation and wide range of legacy models for spare/maintenance.
- Sales Network in 40+ countries worldwide.
- 24 months International Warranty.



Main features

- Current range: from 0,1 A to 12 A.
- Operating Voltage range: from 24 VDC to 230 VAC.
- 230 VAC versions, with power supply directly from the main (110 VAC or 230 VAC).
- UL / CSA certified versions available.



R.T.A. 6 Drives families:

1 EtherCAT

2 CANopen

3 MODBUS TCP/IP

4 STEP & DIRECTION ADVANCED

5 PROGRAMMABLE

6 ANALOG INPUT

EtherCAT

CANopen

Modbus TCP/IP



DRIVE TYPE GLOSSARY

ET EtherCAT

PM PROGRAMMABLE

AD STEP & DIRECTION ADVANCED

MT MODBUS TCP/IP

CO CANopen

AI ANALOG INPUT

1 EtherCAT



- Bus voltage range: 24 VDC-230 VAC**
Rated current: up to 6 A (120% current overboost)
- Extremely wide product portfolio of EtherCAT drives ranging from 25W to 1000W Power.
 - Proven compatibility with most EtherCAT master controllers.
 - Easy setup all through EtherCAT parameters.
 - 1 Firmware for all drivers.
 - Double power supply.
 - Open loop, closed loop and full closed loop.
 - Programmable I/O.
 - Profiles: Homing, PP, CSP, CSV.
 - UL / CSA certified versions.
 - STO (SIL 3 - PL=e) Function available.



AUTO-SYNC FUNCTION TO AVOID LOSS OF SYNCHRONISM / LOSS OF STEP

Table of contents

EtherCAT

	DRIVE TYPE	VOLTAGE RANGE (V)	CURRENT RANGE (A) OVERBOOST	DIMENSIONS (mm)	CERTIFICATIONS	SUGGESTED MOTORS	PAGE
Stand Alone							
CSD ET 94	ET	24 - 48 VDC	4.0 4,8	Box: 130 x 106 x 32 mm Plug-In connectors	CE	Nema 11, Nema 17, Nema 23, 60 mm	50
PLUS ET A3	ET	39 - 85 VDC	6.0 7,2	Box: 152 x 129 x 46 mm Plug-In connectors	CE	Nema 23, 60 mm, Nema 34	52
PLUS ET B3	ET	28 - 62 VDC	6.0 7,2	Box: 152 x 129 x 46 mm Plug-In connectors	CE	Nema 23, 60 mm, Nema 34	52
X-PLUS ET S4	ET	110 - 230 VAC Supply directly from the main	4.0 4,8	Box: 169 x 129 x 46 mm Plug-In connectors	CE,UL,CSA + STO SIL3	Nema 23 or bigger (with rating for high voltage)	54
X-PLUS ET B4	ET	110 - 230 VAC Supply directly from the main	4.0 4,8	Box: 169 x 129 x 46 mm Plug-In connectors	CE,UL,CSA	Nema 23 or bigger (with rating for high voltage)	56
Modular							
FLEX-DRIVE MSE-408	ET	24 - 48 VDC	4.0 4,8	Box: 147 x 17 x 107 mm Plug-In connectors	CE	Nema 11, Nema 17, Nema 23, 60 mm	58
FLEX-DRIVE MSB-204	ET	24 - 48 VDC	2.4 2,9	Box: 147 x 17 x 107 mm Plug-In connectors	CE	Nema 11, Nema 17, Nema 23, 60 mm	58
Combo Unit							
R-MOD ET A3H2ML <i>BATTERYLESS ABSOLUTE ENCODER</i>	ET	24 - 48 VDC	//	//	CE	//	62
R-MOD ET E3H2MA <i>BATTERYLESS ABSOLUTE ENCODER</i>	ET	24 - 48 VDC	//	//	CE	//	62
R-MOD ET A3H2MA	ET	24 - 48 VDC	//	//	CE	//	62
HI-MOD ETS A4F2HL <i>BATTERYLESS ABSOLUTE ENCODER</i>	ET	32 - 75 VDC	//	//	CE,UL,CSA + STO SIL3	//	64
HI-MOD ETS A4F2HC <i>BATTERYLESS ABSOLUTE ENCODER</i>	ET	32 - 75 VDC	//	//	CE,UL,CSA + STO SIL3	//	64
HI-MOD ETS E4F2HC	ET	32 - 75 VDC	//	//	CE,UL,CSA + STO SIL3	//	64
HI-MOD ET E3F2HA	ET	32 - 75 VDC	//	//	CE	//	64

2 CANopen



Operating Bus voltage range:
24 VDC 85 VDC

CANopen

- Microstepping function up to 3200 step/revolution.
- Incremental or absolute encoder function.
- UL / CSA certified versions available.

Table of contents

CANopen

	DRIVE TYPE	VOLTAGE RANGE (V)	CURRENT RANGE (A)	DIMENSIONS (mm)	CERTIFICATIONS	SUGGESTED MOTORS	PAGE
Combo Unit							
HI-MOD A3F1H2 BATTERYLESS ABSOLUTE ENCODER	CO	32 - 75 VDC	//	//	CE	//	68
HI-MOD A3F2H2 BATTERYLESS ABSOLUTE ENCODER	CO	32 - 75 VDC	//	//	CE	//	68
HI-MOD A3F1H5 BATTERYLESS ABSOLUTE ENCODER	CO	32 - 75 VDC	//	//	CE,UL,CSA	//	68
HI-MOD A3F2H5	CO	32 - 75 VDC	//	//	CE,UL,CSA	//	68
HI-MOD E3F1H2	CO	32 - 75 VDC	//	//	CE	//	68
HI-MOD E3F2H2	CO	32 - 75 VDC	//	//	CE	//	68
HI-MOD E3F3H2	CO	32 - 75 VDC	//	//	CE	//	68
HI-MOD E3F1H5	CO	32 - 75 VDC	//	//	CE,UL,CSA	//	68
HI-MOD E3F2H5	CO	32 - 75 VDC	//	//	CE,UL,CSA	//	68
HI-MOD E3F3H5	CO	32 - 75 VDC	//	//	CE,UL,CSA	//	68
Not preferred models							PAGE 70

"Not preferred models" are models which have been replaced with the latest versions. They are still available in R.T.A.'s stock, however they are not recommended for new applications.

3 MODBUS TCP



Operating Bus voltage range:
110 VAC - 230 VAC
Phase current range: 2.4 A - 4.0 A
(120% current overboots)

- Full digital microstepping drive
- Modes of operations: PP, PV, Homing
- Configurable IP address via USB port
- UL / CSA certified versions available



Table of contents

MODBUS TCP

	DRIVE TYPE	VOLTAGE RANGE (V)	CURRENT RANGE (A) OVERBOOST	DIMENSIONS (mm)	CERTIFICATIONS	SUGGESTED MOTORS	PAGE
Stand Alone							
X-PLUS MT.S4	MT	110 - 230 VAC Supply directly from the main	2.4 - 4.0 4,8	Open frame drive: 152 x 129 x 46 mm Plug-In connectors	CE,UL,CSA + STO SIL3	Nema 23 or bigger (with rating for high voltage)	72
X-PLUS MT.B4	MT	110 - 230 VAC Supply directly from the main	2.4 - 4.0 4,8	Open frame drive: 152 x 129 x 46 mm Plug-In connectors	CE,UL,CSA	Nema 23 or bigger (with rating for high voltage)	72

4 STEP & DIRECTION ADVANCED



Bus voltage range: 24 VDC -230 VAC
Phase current range: 0,6 A - 8 A

- Full digital microstepping drive.



STO

SIL3
SAFE TORQUE
OFF (STO)

- Adaptive microstepping up to 12.800 step/revolution (1/64).
- Direct input from the main AC power supply versions available.
- Excellent smoothness of movement.
- Low noise and vibrations.
- UL/CSA certified versions available.

Table of contents

STEP & DIRECTION ADVANCED

	DRIVE TYPE	VOLTAGE RANGE (V)	CURRENT RANGE (A)	DIMENSIONS (mm)	CERTIFICATIONS	SUGGESTED MOTORS	PAGE
BSD 02	AD	24 - 48 VDC	0.7 - 2.2	Open frame drive: 78 x 68 x 21 mm AMP connectors	CE	Nema 11, Nema 17, Nema 23, 60 mm	76
BSD 02.V	AD	24 - 48 VDC	0.7 - 2.2	Open frame drive: 78 x 68 x 21 mm Screw-type connectors	CE	Nema 11, Nema 17, Nema 23, 60 mm	76
BSD 02.S	AD	24 - 48 VDC	0.7 - 2.2	Open frame drive: 78 x 68 x 21 mm Pin connectors	CE	Nema 11, Nema 17, Nema 23, 60 mm	78
A-CSD 02	AD	24 - 48 VDC	0.7 - 2.4	Open frame drive: 92 x 85 x 22 mm AMP connectors	CE	Nema 11, Nema 17, Nema 23, 60 mm	80
A-CSD 02.V	AD	24 - 48 VDC	0.7 - 2.4	Open frame drive: 92 x 85 x 22 mm Screw-type connectors	CE	Nema 11, Nema 17, Nema 23, 60 mm	80
A-CSD 04	AD	24 - 48 VDC	2.6 - 4.4	Open frame drive: 92 x 85 x 23 mm AMP connectors	CE	Nema 11, Nema 17, Nema 23, 60 mm	80
A-CSD 04.V	AD	24 - 48 VDC	2.6 - 4.4	Open frame drive: 92 x 85 x 23 mm Screw-type connectors	CE	Nema 11, Nema 17, Nema 23, 60 mm	80
A-CSD 92	AD	24 - 48 VDC	0.7 - 2.4	Open frame drive: 90 x 99 x 21 mm Plug-In connectors	CE	Nema 11, Nema 17, Nema 23, 60 mm	80
A-CSD 94	AD	24 - 48 VDC	2.6 - 4.4	Open frame drive: 92 x 85 x 22 mm Plug-In connectors	CE	Nema 11, Nema 17, Nema 23, 60 mm	80
HGD 02	AD	24 - 75 VDC	0.75 - 2.0	Open frame drive: 70 x 70 x 25 mm PIN connectors	CE	Nema 17, Nema 23, 60 mm, Nema 34	82
HGD 05	AD	24 - 75 VDC	2,25 - 6,0	Open frame drive: 110 x 108 X 34 mm PIN connectors	CE	Nema 17, Nema 23, 60 mm, Nema 34	82
A-NDC 04	AD	24 - 85 VDC	0.6 - 2.0	Open frame drive: 101 x 94 x 25 mm AMP connectors	CE	Nema 17, Nema 23, 60 mm, Nema 34	84
A-NDC 04.V	AD	24 - 85 VDC	0.6 - 2.0	Open frame drive: 101 x 94 x 25 mm Screw-type connectors	CE	Nema 17, Nema 23, 60 mm, Nema 34	84
A-NDC 06	AD	24 - 85 VDC	1.9 - 6.0	Open frame drive: 101 x 94 x 25 mm AMP connectors	CE	Nema 17, Nema 23, 60 mm, Nema 34	84

STEP & DIRECTION ADVANCED

	DRIVE TYPE	VOLTAGE RANGE (V)	CURRENT RANGE (A)	DIMENSIONS (mm)	CERTIFICATIONS	SUGGESTED MOTORS	PAGE
A-NDC 06.V	AD	24 - 85 VDC	1.9 - 6.0	Open frame drive: 101 x 94 x 25 mm Screw-type connectors	CE	Nema 17, Nema 23, 60 mm, Nema 34	84
A-NDC 94	AD	24 - 85 VDC	0.6 - 2.0	Open frame drive: 110 x 108 x 34 mm Plug-In connectors	CE	Nema 17, Nema 23, 60 mm, Nema 34	84
A-NDC 96	AD	24 - 85 VDC	1.9 - 6.0	Open frame drive: 110 x 108 x 34 mm Plug-In connectors	CE	Nema 17, Nema 23, 60 mm, Nema 34	84
X-PLUS L2	AD	110 - 230 VAC Supply directly from the main	1.4 - 2.5	Open frame drive: 152 x 129 x 30 mm Plug-In connectors	CE	Nema 23 or bigger (with rating for high voltage)	86
X-PLUS B4.1	AD	110 - 230 VAC Supply directly from the main	2.4 - 4.0	Open frame drive: 152 x 129 x 46 mm Plug-In connectors	CE	Nema 23 or bigger (with rating for high voltage)	88
X-PLUS S4.1	AD	110 - 230 VAC Supply directly from the main	2.4 - 4.0	Open frame drive: 152 x 129 x 46 mm Plug-In connectors	CE,UL,CSA + STO SIL3	Nema 23 or bigger (with rating for high voltage)	90
X-PLUS C4.1	AD	110 - 230 VAC Supply directly from the main	2.4 - 4.0	Open frame drive: 152 x 129 x 46 mm Plug-In connectors	CE,UL,CSA	Nema 23 or bigger (with rating for high voltage)	92

Not preferred models

PAGE 94

"Not preferred models" are models which have been replaced with the latest versions. They are still available in R.T.A.'s stock, however they are not recommended for new applications.

5 PROGRAMMABLE



Operating Bus voltage range: 28 VAC - 230 VAC
Phase current range: 0,1 A - 8 A

- Microstepping function up to 4000 step/revolution.



- Communication through RS485 serial line.
- Motor loss of synchronism alarm function available.
- Direct input from the main AC power supply versions available.

Table of contents

PROGRAMMABLE

	DRIVE TYPE	VOLTAGE RANGE (V)	CURRENT RANGE (A)	DIMENSIONS (mm)	CERTIFICATIONS	SUGGESTED MOTORS	PAGE
CSD J2	PM/AI	24 - 48 VDC	1.2 - 2.1	Box: 90 x 99 x 30 mm Plug-In connectors	CE	Nema 11, Nema 17, Nema 23, 60 mm	98
CSD J4	PM/AI	24 - 48 VDC	2.6 - 4.4	Box: 90 x 99 x 30 mm Plug-In connectors	CE	Nema 11, Nema 17, Nema 23, 60 mm	98
PLUS J5	PM/AI	28 - 62 VAC	4.4 - 8.0	Box: 152 x 129 x 46 mm Plug-In connectors	CE	Nema 17, Nema 23, 60 mm, Nema 34	100
PLUS K4	PM	55 - 100 VAC	3.4 - 6.0	Box: 152 x 129 x 46 mm Plug-In connectors	CE	Nema 17, Nema 23, 60 mm, Nema 34	102
PLUS K5	PM	28 - 62 VAC	4.4 - 8.0	Box: 152 x 129 x 46 mm Plug-In connectors	CE	Nema 17, Nema 23, 60 mm, Nema 34	102
X-MIND K4	PM	110 - 230 VAC Supply directly from the main	2.3 - 4.0	Box: 180 x 173 x 53 mm Plug-In connectors	CE	Nema 23 or bigger (with rating for high voltage)	104
X-MIND K6	PM	110 - 230 VAC Supply directly from the main	3.4 - 6.0	Box: 180 x 173 x 53 mm Plug-In connectors	CE	Nema 34 or bigger (with rating for high voltage)	104

Not preferred models

PAGE 106

"Not preferred models" are models which have been replaced with the latest versions. They are still available in R.T.A.'s stock, however they are not recommended for new applications.

6 ANALOG INPUT



Bus voltage range: 24 VDC - 100 VAC
Phase current range: 0,6 A - 6 A

- Microstepping function up to 4000 step/revolution.



- Intelligent management of the current profile.
- Excellent smoothness of movement.
- Low noise and vibrations.

Table of contents

ANALOG INPUT

	DRIVE TYPE	VOLTAGE RANGE (V)	CURRENT RANGE (A)	DIMENSIONS (mm)	CERTIFICATIONS	SUGGESTED MOTORS	PAGE
ADW 04	AI	24 - 75 VDC	0.65 - 2.0	Open-frame drive: 122 x 94 x 25 mm AMP connectors	CE	Nema 17, Nema 23, 60 mm, Nema 34	108
ADW 04.V	AI	24 - 75 VDC	0.65 - 2.0	Open-frame drive: 122 x 94 x 25 mm Screw-type connectors	CE	Nema 17, Nema 23, 60 mm, Nema 34	108
ADW 06	AI	24 - 75 VDC	1.9 - 6.0	Open-frame drive: 122 x 94 x 25 mm AMP connectors	CE	Nema 17, Nema 23, 60 mm, Nema 34	108
ADW 06.V	AI	24 - 75 VDC	1.9 - 6.0	Box: 122 x 94 x 25 mm Screw-type connectors	CE	Nema 17, Nema 23, 60 mm, Nema 34	108
ADW 94	AI	24 - 75 VDC	0.65 - 2.0	Box: 152 x 129 x 46 mm Plug-In connectors	CE	Nema 17, Nema 23, 60 mm, Nema 34	108
ADW 96	AI	24 - 75 VDC	1.9 - 6.0	Box: 152 x 129 x 46 mm Plug-In connectors	CE	Nema 17, Nema 23, 60 mm, Nema 34	108

ACCESSORIES - SWITCHING POWER SUPPLY

	NOMINAL POWER (W)	INPUT (V)	OUTPUT (V)	DIMENSIONS (mm)	CERTIFICATIONS	PAGE
R-UHP 200-XX	200	90 - 264	12 VDC 24 VDC 48 VDC	194 x 55 x 26	CE	112
R-UHP 350-XX	350	90 - 264	12 VDC 24 VDC 48 VDC	220 x 62 x 31	CE	114
R-UHP 500-XX	500	90 - 264	12 VDC 24 VDC 48 VDC	232 x 81 x 31	CE	116
R-NDR 240-XX	240	90 - 264	24 VDC 48 VDC	125 x 64 x 114	CE	118
R-NDR 480-XX	480	90 - 264	24 VDC 48 VDC	125 x 86 x 129	CE	120

STEPPING MOTOR DRIVES

EtherCAT





CSD ET 94 Series Drives



EtherCAT®

INTRODUCTION

- New series of stepping motor drives with EtherCAT interface, now available with a 3rd generation firmware release (2021).
- Drives optimized for coupling with SANYO DENKI stepping motors, fitted with encoder, but also able to manage third parts motors.
- Compact system, developed to offer a wide variety of integrated functions and optimized for the most demanding motion control applications.

MAIN EtherCAT® FEATURES

- Modes of operation: PP, PV, Homing, CSP and CSV.
- Wide range of motor phase current setting and motor current overboost (120%).
- Different variety of HOMING operation modes.
- Encoder feedback and support of different resolution.
- Touch Probe function available.
- Limit switches management.
- Auto-sync function available featuring a closed loop positioning.
- 5 + 5 I/Os.



Please refer to download.rta.it for technical specifications

Series	Model	V _{DC} range (Volt)	I nom. (Amp)	Digital In/Out	Dimensions (mm)
CSD ET	94	24 to 48	4.0	5/5	130x106x32

TECHNICAL FEATURES

- Range of operating voltage 24-48 VDC.
- Protections:
 - Protection against under-voltage and over-voltage.
 - Protection against a short-circuit at motor outputs.
 - Overtemperature protection.
- Electronic damping facility for further acoustic noise and mechanic vibrations reduction.
- Available in plastic boxed version with plug-in connectors.
- Maximum compactness.
- Optoinsulated auxiliary and programmable inputs and outputs.
- Warranty: 24 months.

EtherCAT[®]

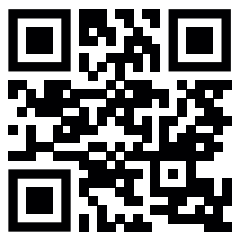

SCAN THE QR CODE TO WATCH A VIDEO ON THE AUTO-SYNC FUNCTION



POWER AND LOGIC CONNECTIONS

R. T.A. MOTORS
RH/EM SERIES

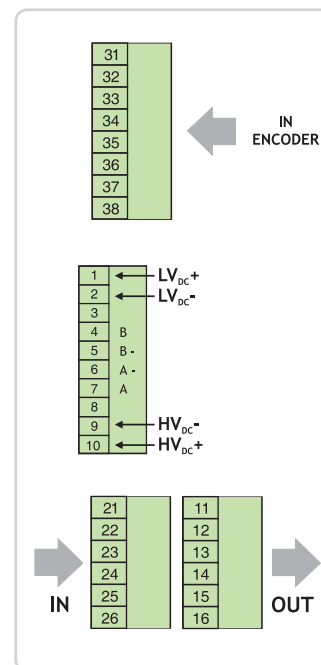

MECHANICAL DIMENSIONS

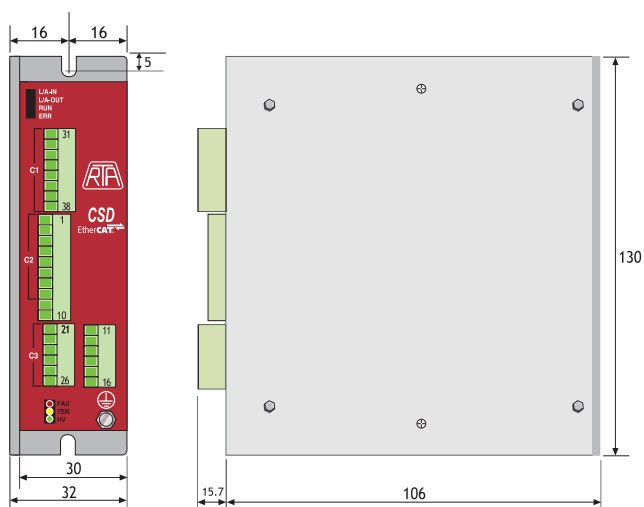

CSD ET
HIGH SIDE VIEW

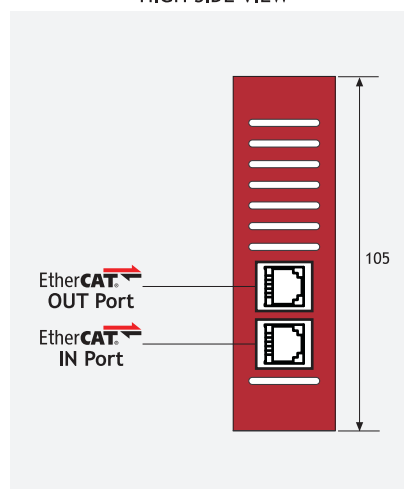

Dimensions in millimeters - Not in scale.

PLUS ET Series Drives



EtherCAT®

INTRODUCTION

- New series of stepping motor drives with EtherCAT interface, now available with a 3rd generation firmware release (2021).
- Drives optimized for coupling with SANYO DENKI stepping motors, fitted with encoder, but also able to manage third parts motors.
- Compact system, developed to offer a wide variety of integrated functions and optimized for the most demanding motion control applications.

MAIN EtherCAT® FEATURES

- Modes of operation: PP, PV, Homing, CSP and CSV.
- Wide range of motor phase current setting and motor current overboost (120%).
- Different variety of HOMING operation modes.
- Encoder feedback and support of different resolution.
- Touch Probe function available.
- Limit switches management.
- Auto-sync function available featuring a closed loop positioning.
- 4 + 3 I/Os.



Please refer to download.rta.it for technical specifications

Series	Model	V _{AC} range (Volt)	V _{DC} range (Volt)	I nom. (Amp)	Digital In/Out	Dimensions (mm)
PLUS ET	A3	/	39 to 85	6.0	4/3	152x129x46
PLUS ET	B3	28 to 62	/	6.0	4/3	152x129x46

TECHNICAL FEATURES

- Range of operating voltage: 39-85 VDC (PLUS ET A3) and 28-62 VAC (PLUS ET B3).
- Protections:
 - Protection against under-voltage and over-voltage.
 - Protection against a short-circuit at motor outputs.
 - Overtemperature protection.
- Electronic damping facility for further acoustic noise and mechanic vibrations reduction.
- Available in plastic boxed version with plug-in connectors.
- Maximum compactness.
- Optoinsulated auxiliary and programmable inputs and outputs.
- External fans not needed.
- Warranty: 24 months.

EtherCAT[®]

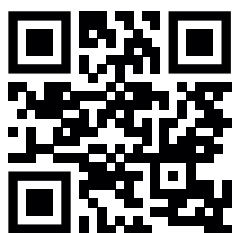

SCAN THE QR CODE TO WATCH A VIDEO ON THE AUTO-SYNC FUNCTION



POWER AND LOGIC CONNECTIONS

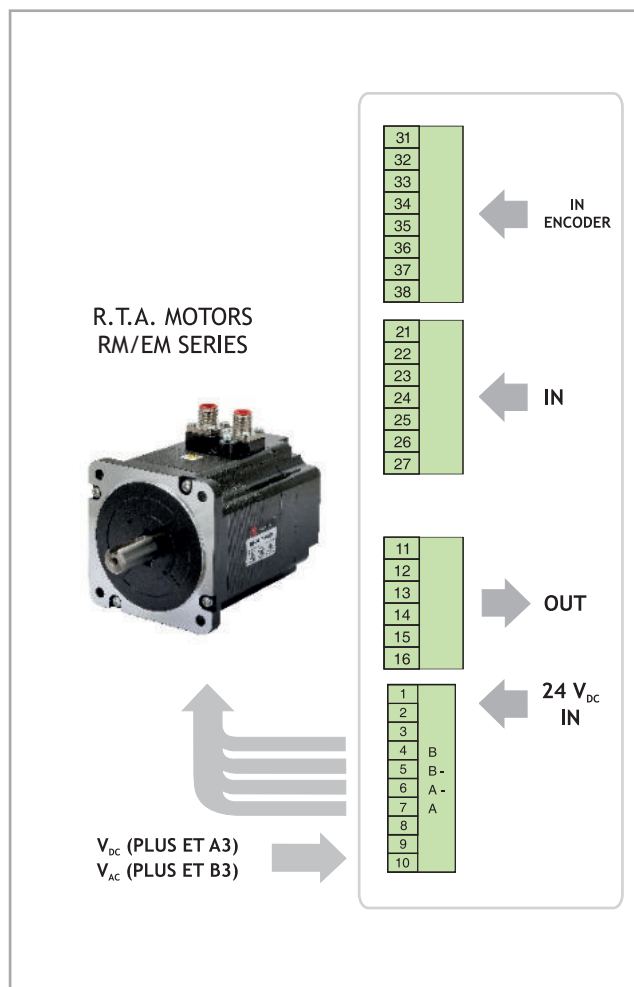

MECHANICAL DIMENSIONS

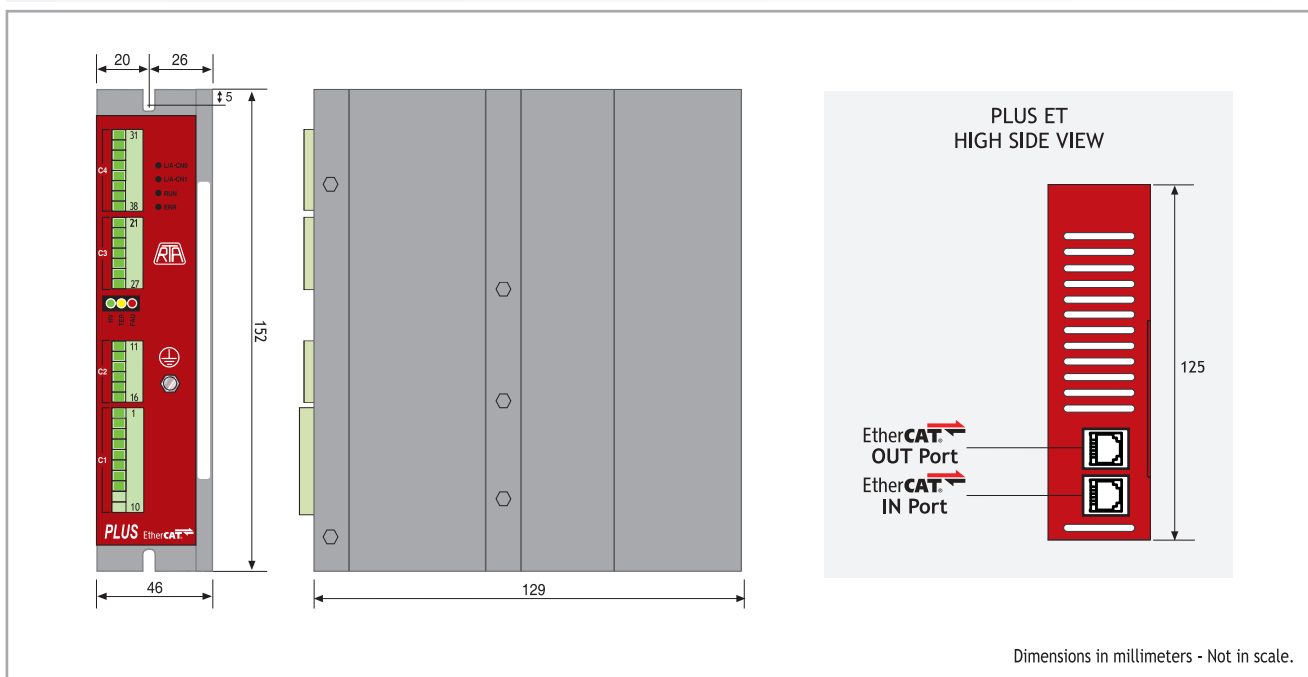

X-PLUS ET S4 Series Drives

EtherCAT®

3rd
FIRMWARE
GENERATION

INTRODUCTION

- New series of stepping motor drives with EtherCAT interface, direct input from the main AC power supply (from 110 VAC to 230 VAC) and STO function.
- Drives optimized for coupling with SANYO DENKI stepping motors, fitted with encoder, but also able to manage third parts motors.
- High performance in terms of power and able to further increase the application potential.
- Compact system, developed to offer a wide variety of integrated functions and optimized for the most demanding motion control applications.

MAIN EtherCAT® FEATURES

- Modes of operation: PP, PV, Homing, CSP and CSV.
- Wide range of motor phase current setting and motor current overboost (120%).
- Different variety of HOMING operation modes.
- Encoder feedback and support of different resolution.
- Touch Probe function available.
- Limit switches management.
- 4 + 3 I/Os and 2 STO.
- Auto-sync function available featuring a closed loop positioning.

SIL3
SAFE TORQUE
OFF (STO)

STO
X-PLUS
EtherCAT®

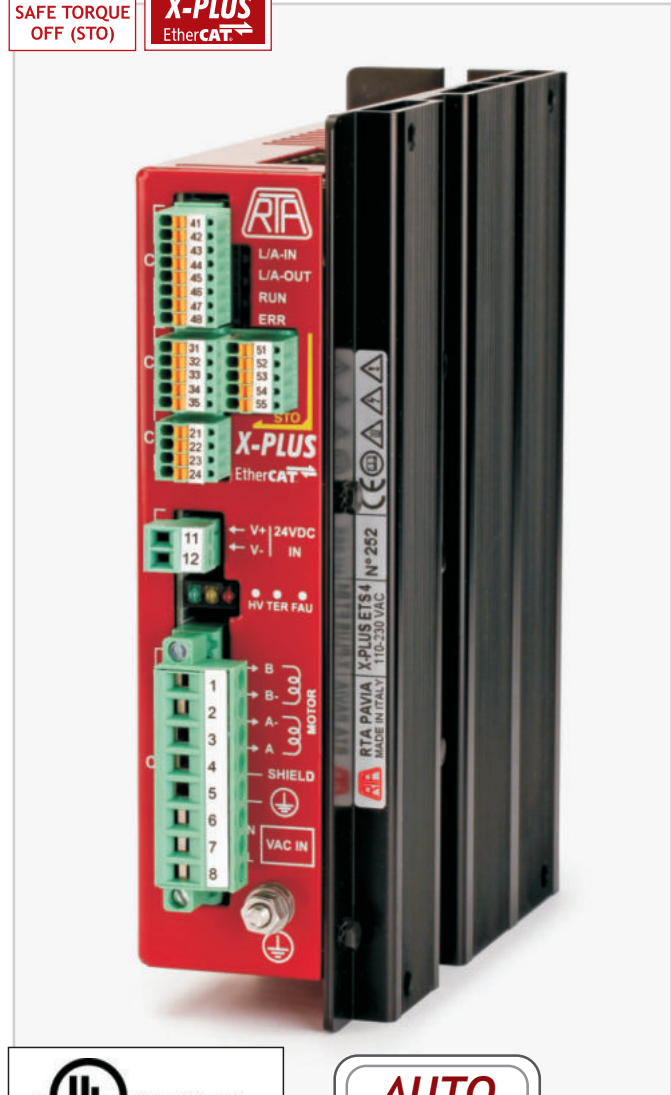

UL US LISTED
FILE NUMBER: E306454

**AUTO
SYNC**
FUNCTION

Please refer to download.rta.it
for technical specifications

STO FUNCTION FEATURES

- Safe Torque Off (STO) function - **SIL3**
- Error Detection Monitor

SIL3
SAFE TORQUE
OFF (STO)

Series	Model	V _{AC} range (Volt)	I nom. (Amp)	Digital In/Out	STO In	Dimensions (mm)
X-PLUS ET	S4	110 to 230 +/- 15%	4.0	4/3	2	169x129x46

TECHNICAL FEATURES

- Possibility to switch off motor current by means of STO function.
- Range of operating voltage 110-230 VAC.
- Protections:
 - Protection against under-voltage and over-voltage.
 - Protection against a short-circuit at motor outputs.
 - Overtemperature protection.
- Electronic damping facility for further acoustic noise and mechanic vibrations reduction.
- Available in boxed version with plug-in connectors.
- Maximum compactness.
- Optoinsulated auxiliary and programmable inputs and outputs.
- External fans not needed.
- UL / CSA certified.
- Warranty: 24 months.

EtherCAT®

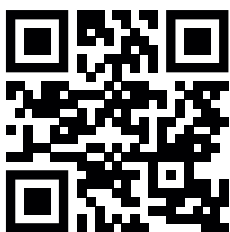

SCAN THE QR CODE TO WATCH A VIDEO ON THE AUTO-SYNC FUNCTION



POWER AND LOGIC CONNECTIONS

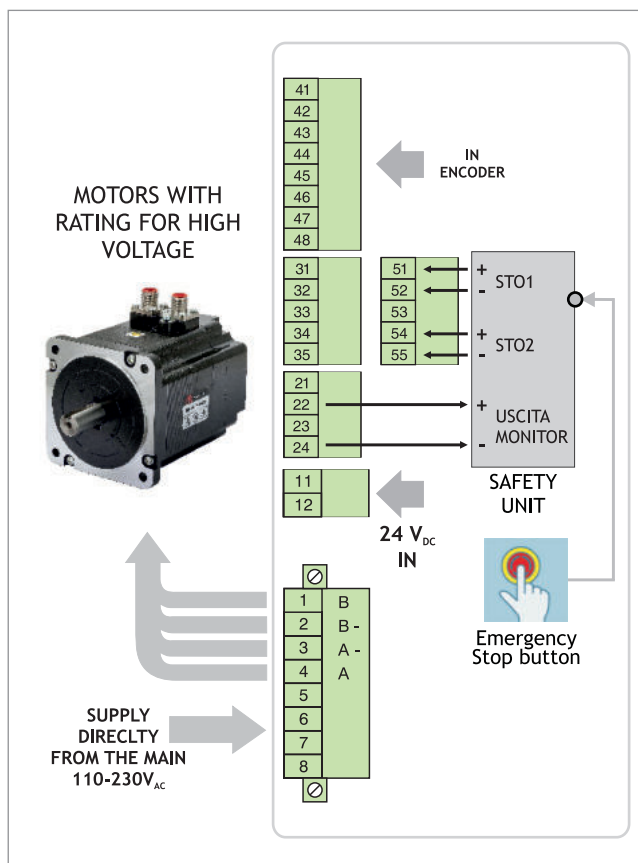

STO FUNCTION FEATURES

- Safe Torque Off (STO) function [SIL3]
- Error Detection Monitor



MECHANICAL DIMENSIONS

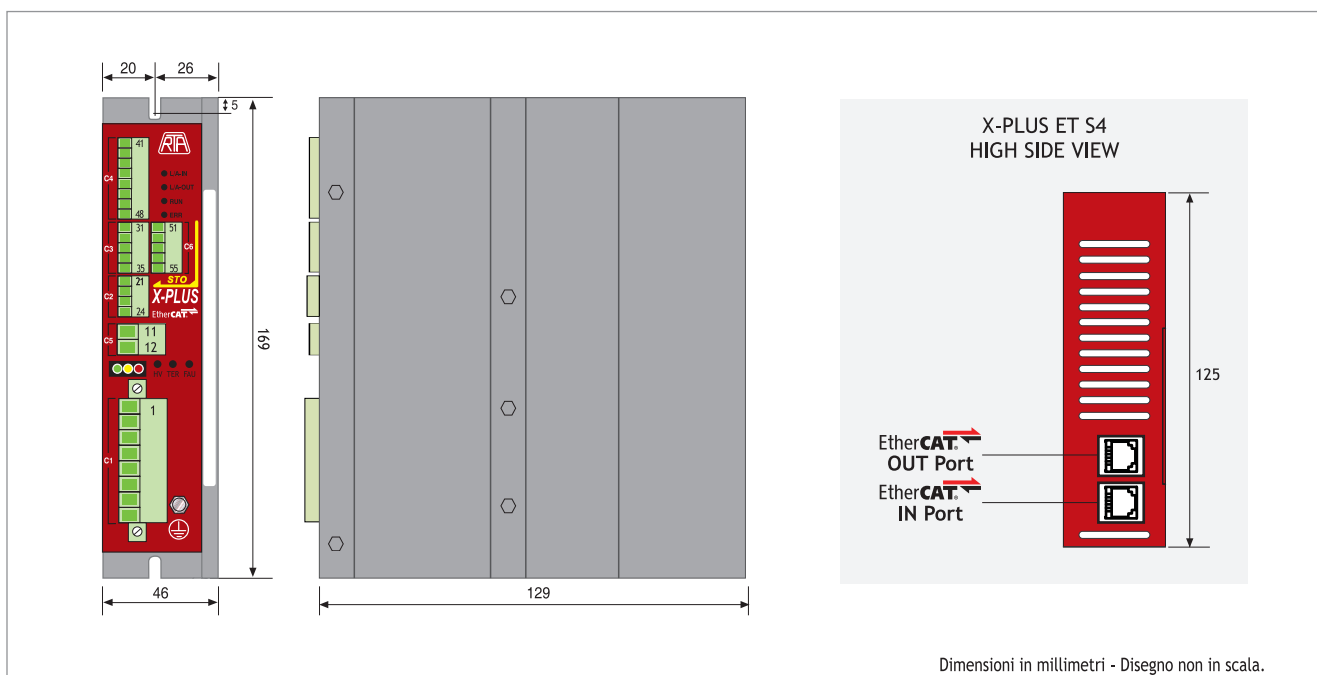

X-PLUS ET B4 Series Drives



EtherCAT®

INTRODUCTION

- New series of stepping motor drives with EtherCAT interface, direct input from the main AC power supply (from 110 VAC to 230 VAC).
- Drives optimized for coupling with SANYO DENKI stepping motors, fitted with encoder, but also able to manage third parts motors.
- High performance in terms of power and able to further increase the application potential.
- Compact system, developed to offer a wide variety of integrated functions and optimized for the most demanding motion control applications.

MAIN EtherCAT® FEATURES

- Modes of operation: PP, PV, Homing, CSP and CSV.
- Wide range of motor phase current setting and motor current overboost (120%).
- Different variety of HOMING operation modes.
- Encoder feedback and support of different resolution.
- Touch Probe function available.
- Limit switches management.
- Auto-sync function available featuring a closed loop positioning.
- 4 + 3 I/Os.

Please refer to download.rta.it for technical specifications

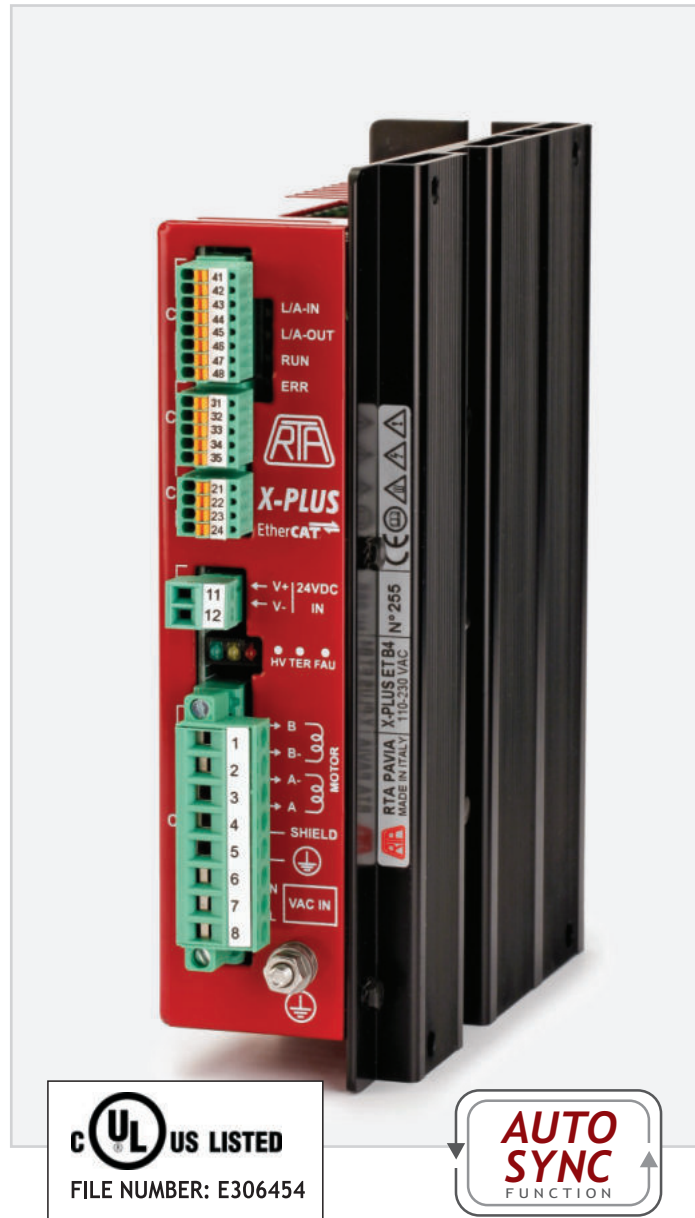

Series	Model	V _{ac} range (Volt)	I nom. (Amp)	Digital In/Out	Dimensions (mm)
X-PLUS ET	B4	110 to 230 +/- 15%	4.0	4/3	169x129x46

TECHNICAL FEATURES

- Range of operating voltage 110-230 VAC.
- Protections:
 - Protection against under-voltage and over-voltage.
 - Protection against a short-circuit at motor outputs.
 - Overtemperature protection.
- Electronic damping facility for further acoustic noise and mechanic vibrations reduction.
- Available in boxed version with plug-in connectors.
- Maximum compactness.
- Optoinsulated auxiliary and programmable inputs and outputs.
- External fans not needed.
- UL / CSA certified.
- Warranty: 24 months.

EtherCAT

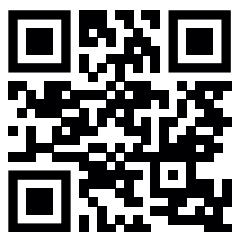

SCAN THE QR CODE TO
WATCH A VIDEO ON THE
AUTO-SYNC FUNCTION



POWER AND LOGIC CONNECTIONS

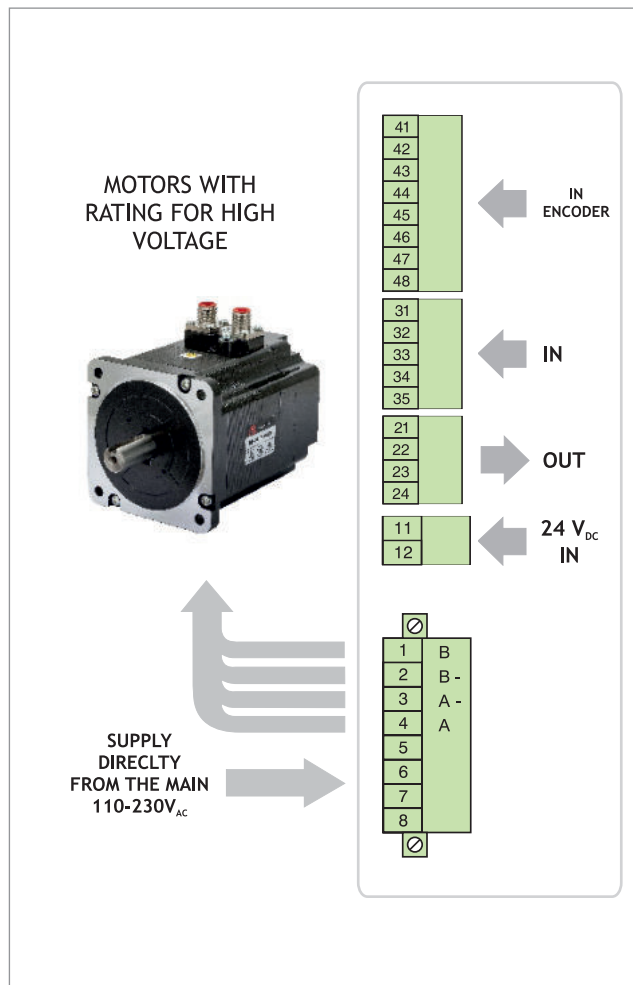

MECHANICAL DIMENSIONS

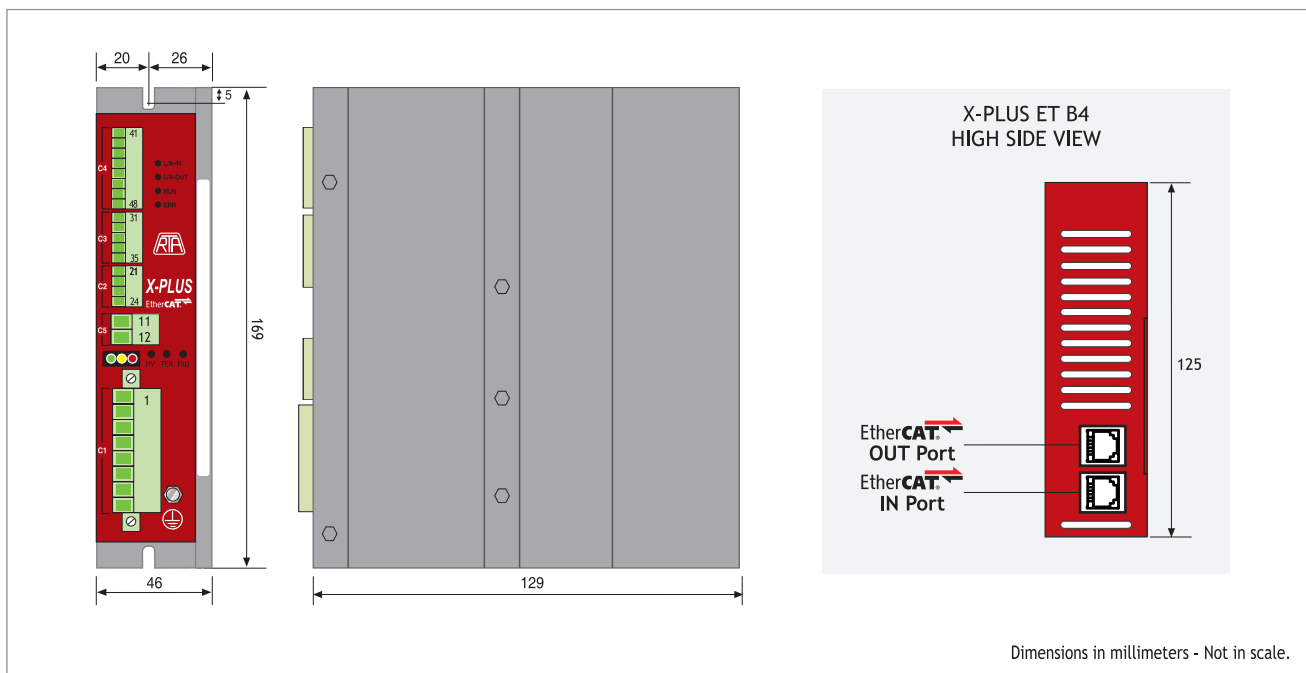

FLEX-DRIVE Series Drives

3rd
FIRMWARE
GENERATION

EtherCAT®

INTRODUCTION

- FLEX-DRIVE allows connection with any stepper motor up to Nema 24 (60 mm) with or without encoder feedback, supporting PP, CSP, CSV and Homing mode of operation.
- MSE 408 model is equipped with one configurable fast capture input, suitable for Touch Probe, proximity or free use.
- Easy setup: no need of programming software, all settings are made through EtherCAT network.
- Separated power supply for logic circuit and motor power.

MAIN EtherCAT® FEATURES

- Modes of operation: PP, PV, Homing, CSP and CSV.
- Wide range of motor phase current setting and motor current overboost (120%).
- Different variety of HOMING operation modes.
- Encoder feedback and support of different resolution.
- Touch Probe function available.
- Limit switches management.
- Auto-sync function available featuring a closed loop positioning.

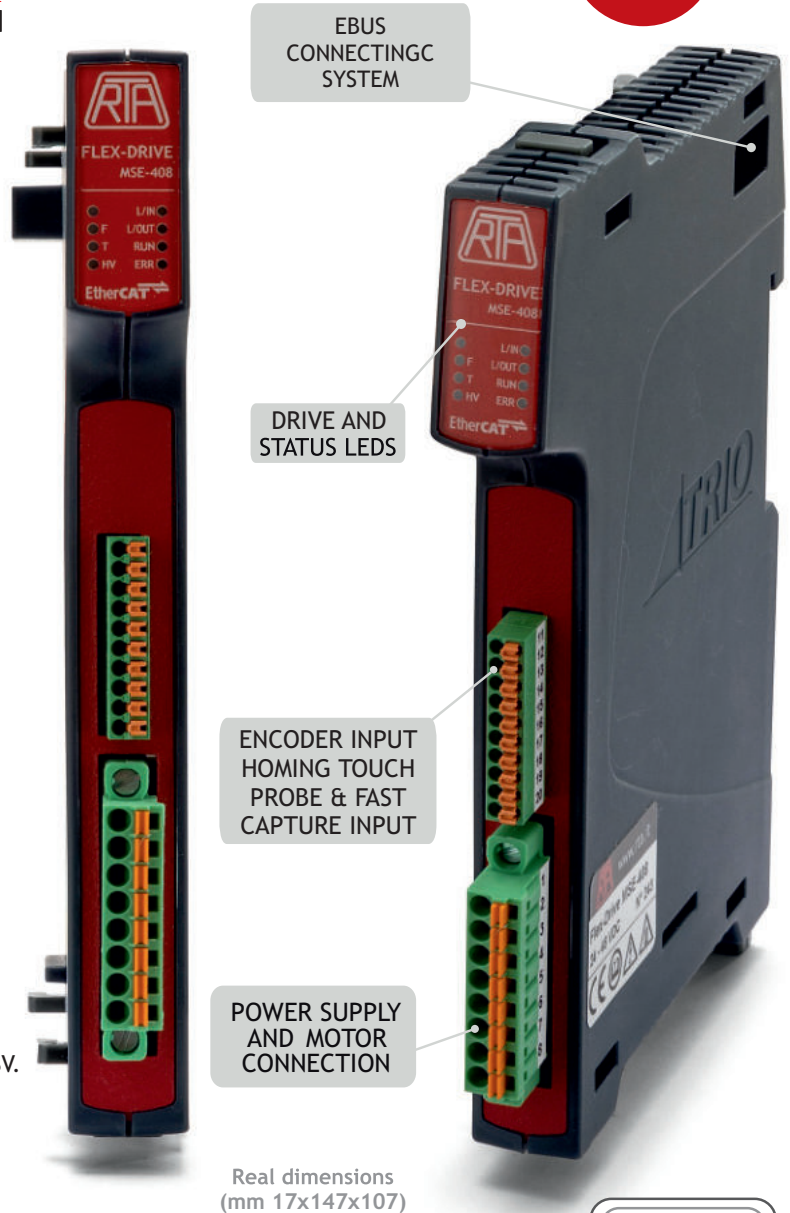

Please refer to download.rta.it for technical specifications



FLEX-DRIVE



SCAN THE QR CODES TO WATCH TWO VIDEOS ON FLEX-DRIVE AND AUTO-SYNC FUNCTION

AUTO-SYNC



MODELS AND FEATURES



MSE 408 Model

- Voltage: 24-48 VDC
- I_{NP} (Peak value): 4 A
- Sensor Feedback: ENCODER or OPEN LOOP



MSB 204 Model

- Voltage: 24-48 VDC
- I_{NP} (Peak value): 2.5 A
- Sensor Feedback: OPEN LOOP

PERFECTLY FITTING THE FLEXSLICE ARCHITECTURE

- The Flex-Drive series is designed to fit into FLEXSLICE SYSTEM, the modular EtherCAT architecture by TRIO MOTION TECHNOLOGY
- The direct connection with FLEX-6-NANO or Flex Ethercat COUPLER creates a powerful multiaxis modular system, composed by Motion Controller, stepping motor drives, digital and analogue I/Os, all sharing same internal EBUS and logic power supply.

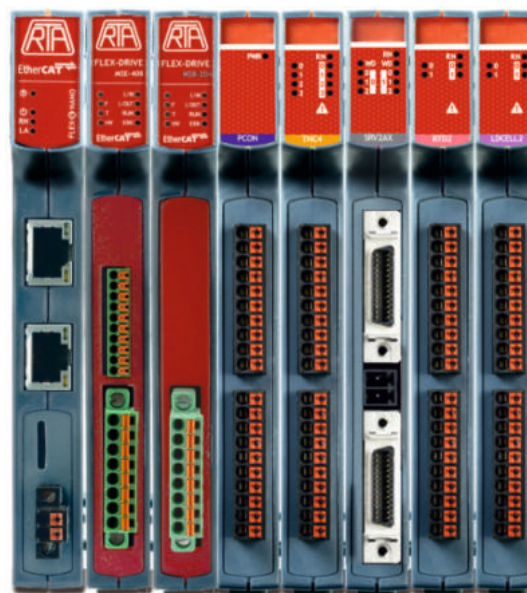

FAST & EASY ASSEMBLY

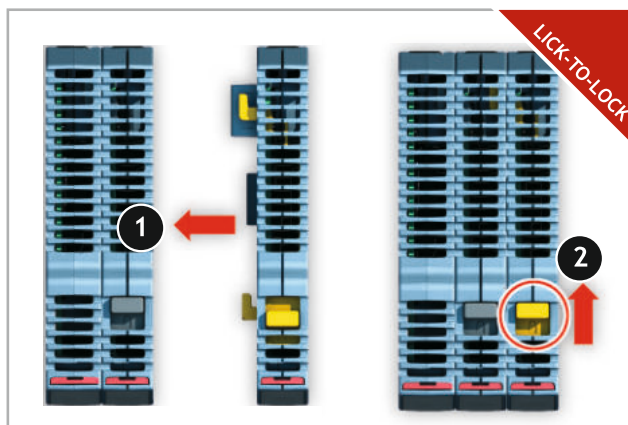

MECHANICAL DIMENSIONS

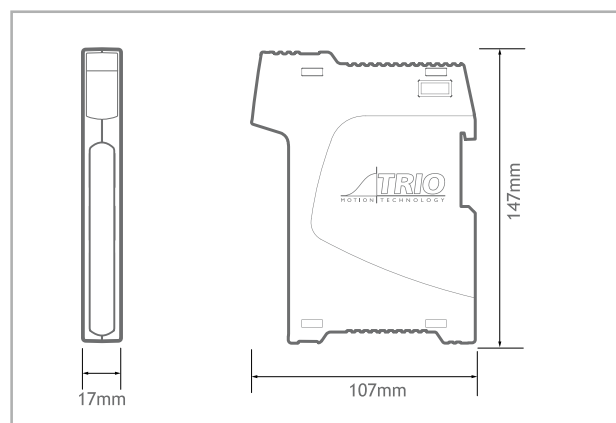

HI-MOD and R-MOD series Combo Units

INTRODUCTION

First developed in 2004, the Combo Unit solution consists in two series of stepping motors in five sizes, with integrated drives based on EtherCAT or CANopen interface, with incremental or battery-less multi-turn absolute encoder.

It is a compact system housed in a metallic box mounted on motor body, minimizing dimensions and optimizing wiring and mounting easiness.

R.T.A. Combo Units are the ideal integrated solution for advanced applications requiring compact dimensions and ensuring perfect integration in complex architectures.



COMBO UNITS EVOLUTION

- 2004: *First Release*
- 2006: *CANopen version*
- 2012: *UL Certification*
- 2014: *EtherCAT version*
- 2016: *STO Function*
- 2021: *Auto-Sync Function*

HIGHLIGHTS

- Holding Torque up to 920 Ncm
- Auto-sync function available featuring a closed loop positioning.
- Battery-less multi-turn ABSOLUTE ENCODER versions
- STO Function - SIL3 with Error Detection Monitor
- Different HOMING operation modes
- UL/CSA Certified

Front Brake and/or Gearbox versions available

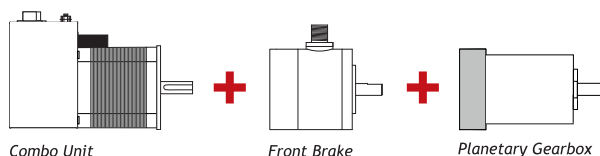

Power Supply, I/O, STO connector

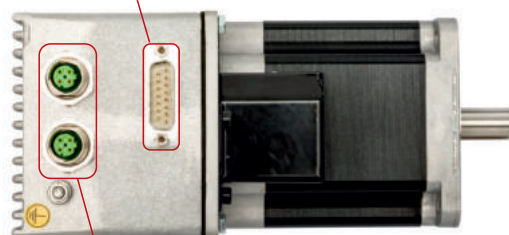

M12 EtherCAT IN / OUT connectors

Power Supply, I/O connector

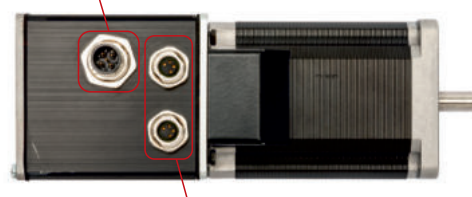

M8 EtherCAT IN / OUT connectors



HI-MOD series

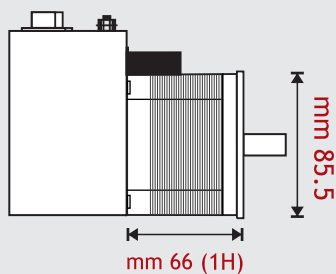

Holding Torque: 360 Ncm

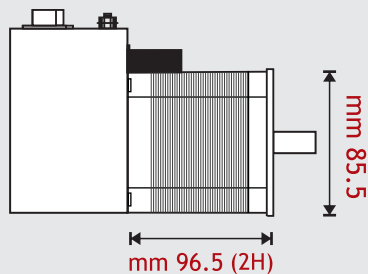

Holding Torque: 700 Ncm

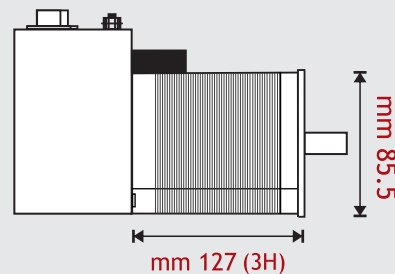

Holding Torque: 920 Ncm

R-MOD series

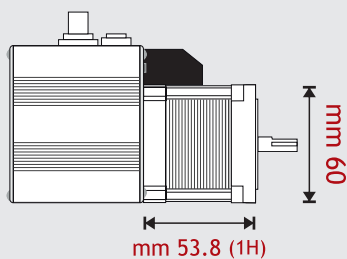

Holding Torque: 170 Ncm

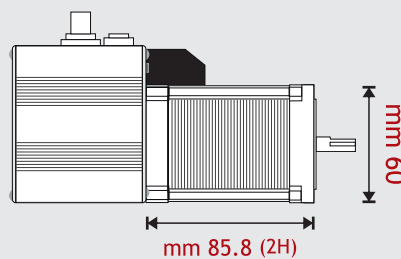

Holding Torque: 300 Ncm

R-MOD ET Combo Unit



EtherCAT®

INTRODUCTION

R-MOD ET is a series of stepping motors in two sizes with integrated ministep bipolar chopper EtherCAT drives, based on incremental or battery-less multi-turn absolute encoder.

HIGHLIGHTS

- Two motor sizes
- Holding Torque up to 300 Ncm
- Communication by means of EtherCAT interface
- Different Operation Modes
- Available Inputs / Outputs
- Different HOMING operation modes
- PROXIMITY hardware input
- AUTO-SYNC function
- Battery-less Multi-turn ABSOLUTE ENCODER versions
- UL/CSA Certified

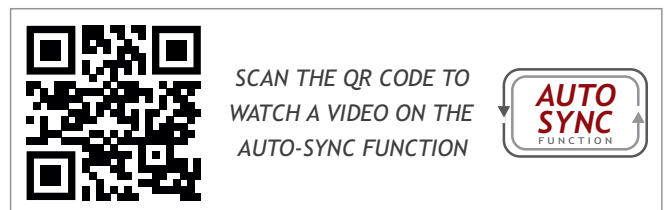
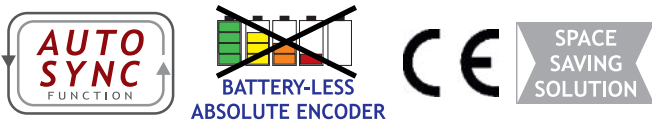
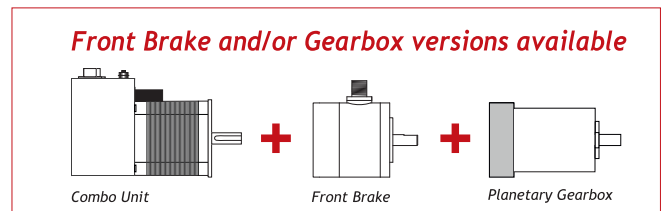

Please refer to download.rta.it for technical specifications

Models	Motor Length (mm)	Holding Torque (Ncm)	Encoder Type	Digital In/Out	Certifications
R-MOD ET A3H2ML	85.8	300	Battery-less Multi-turn Absolute	1/0	CE
R-MOD ET E3H2MA	85.8	300	Incremental	1/0	CE
R-MOD ET A3H2MA	85.8	300	Battery-less Multi-turn Absolute	1/0	CE

SIZES AND PERFORMANCES

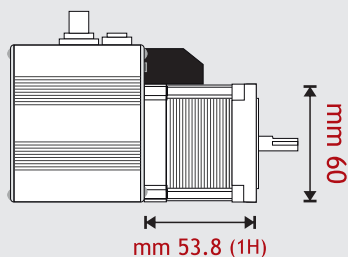

Holding Torque: 170 Ncm

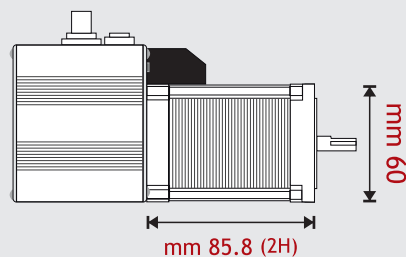

Holding Torque: 300 Ncm

CONNECTION SCHEME

CN1

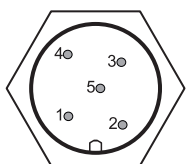

- 1: Input (PX / Touch probe)
- 2: Power supply
- 3: Input (PX / Touch probe)
- 4: GND
- 5: Logic power supply

CN2



**EtherCAT
OUT
(Female)**

CN3



**EtherCAT
IN
(Female)**

- 1: Transmit Data +
- 2: Receive Data +
- 3: Transmit Data -
- 4: Receive data -

TORQUE/SPEED CURVE

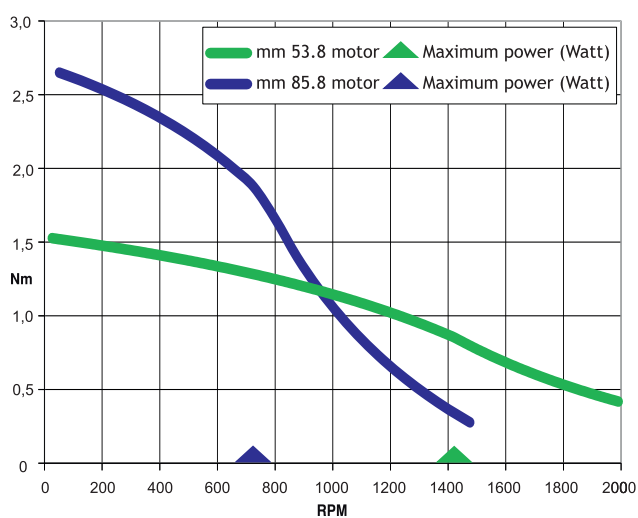

MECHANICAL DIMENSIONS (mm)

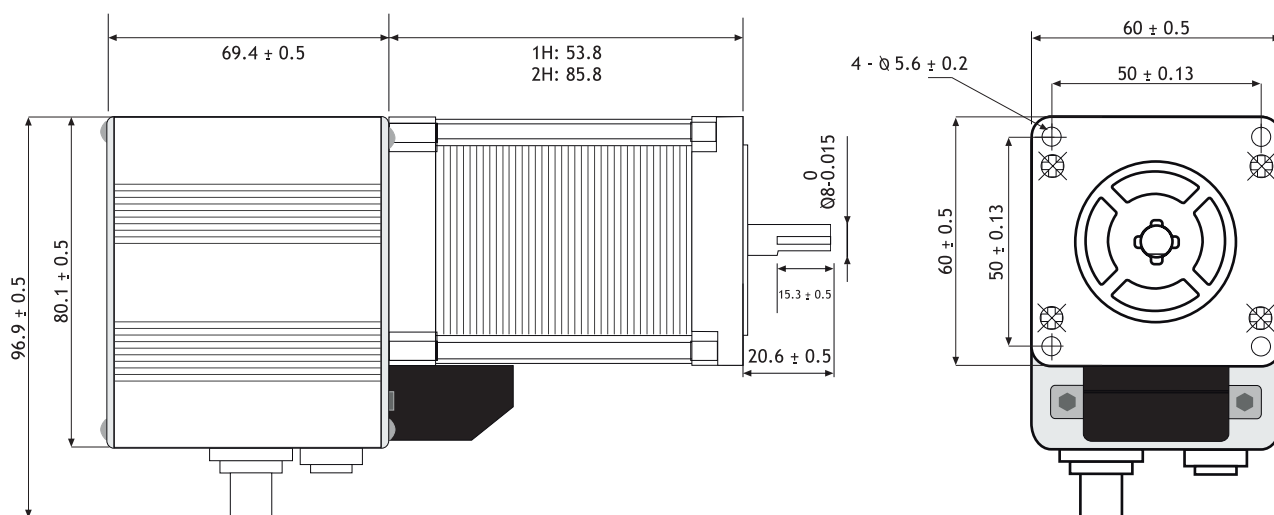

Starter kit and cable set available.

HI-MOD ETS Combo Unit



EtherCAT®

INTRODUCTION

HI-MOD ETS is a series of stepping motors in three sizes with integrated ministep bipolar chopper EtherCAT drives and STO Function, based on incremental or battery-less multi-turn absolute encoder.

HIGHLIGHTS

- Three motor sizes
- Holding Torque up to 920 Ncm
- Communication by means of EtherCAT interface
- Different Operation Modes
- Available Inputs / Outputs
- Different HOMING operation modes
- PROXIMITY hardware input
- AUTO-SYNC function
- Battery-less Multi-turn ABSOLUTE ENCODER versions
- STO Function - SIL3 with Error Detection Monitor

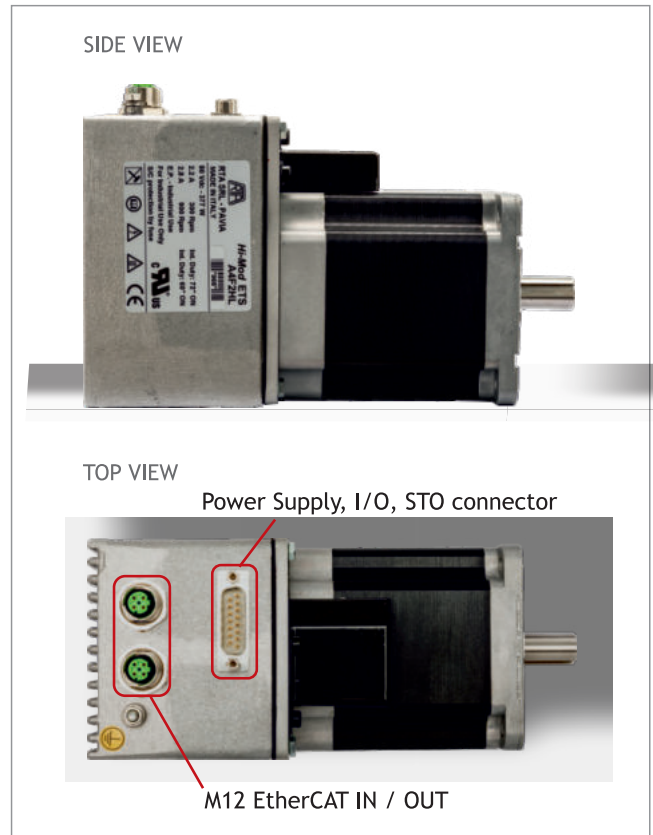

Front Brake and/or Gearbox versions available

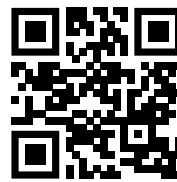
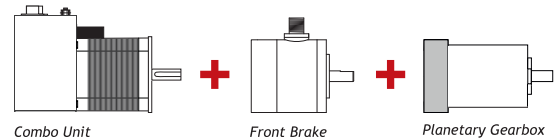

SCAN THE QR CODE TO WATCH A VIDEO ON THE AUTO-SYNC FUNCTION



Please refer to download.rta.it for technical specifications

Models	Motor Length (mm)	Holding Torque (Ncm)	Encoder Type	Digital In/Out	STO In	Certifications
HI-MOD ETS A4F2HL	96.5	700	Battery-less Multi-turn Absolute	2/2	2	CE,UL,CSA + STO SIL3
HI-MOD ETS A4F2HC	96.5	700	Battery-less Multi-turn Absolute	2/2	2	CE,UL,CSA + STO SIL3
HI-MOD ETS E4F2HC	96.5	700	Incremental	2/2	2	CE,UL,CSA + STO SIL3
HI-MOD ET E3F2HA	96.5	700	Incremental	1/0	/	CE

SIZES AND PERFORMANCES

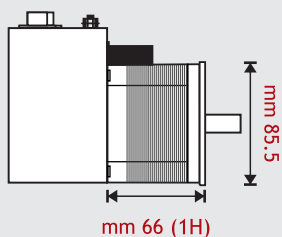

Holding Torque: 360 Ncm

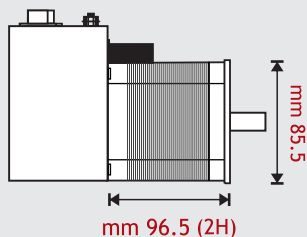

Holding Torque: 700 Ncm

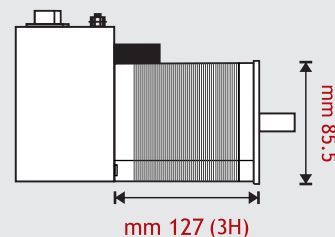

Holding Torque: 920 Ncm

CONNECTION SCHEME

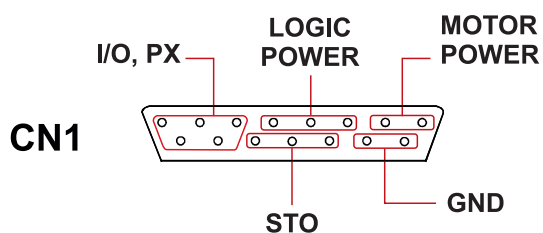

CN2



**EtherCAT
OUT
(Female)**

CN3

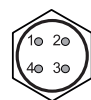

**EtherCAT
IN
(Female)**

- 1: Transmit Data +
- 2: Receive Data +
- 3: Transmit Data -
- 4: Receive data -

TORQUE/SPEED CURVE

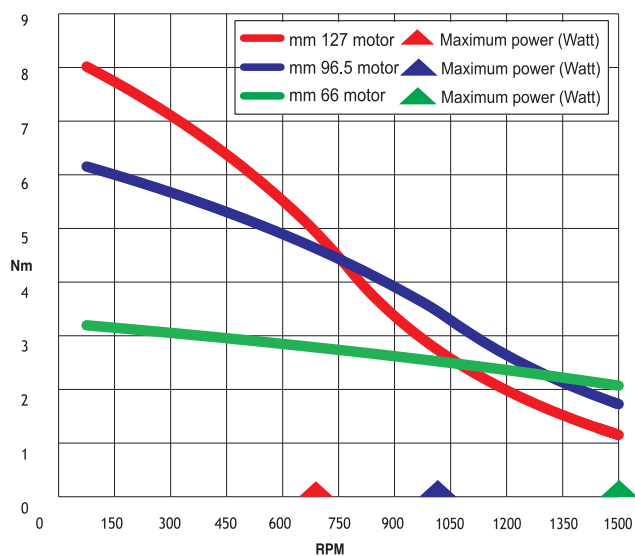

MECHANICAL DIMENSIONS (mm)

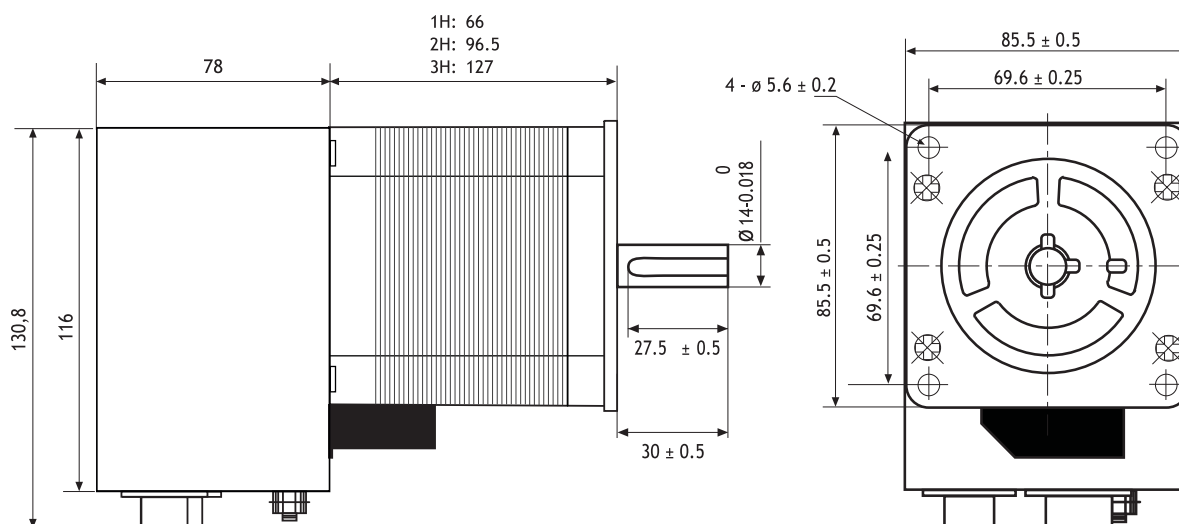

Starter kit and cable set available.

STEPPING MOTOR DRIVES

CANopen



HI MOD A/E Combo Unit



INTRODUCTION

- Series of stepper motors with integrated ministep bipolar chopper drives equipped with programmable motion controller. Setting by means of CANopen interface.
 - Hi-Mod E with Incremental Encoder
 - Hi-Mod A with Absolute Encoder
- Compact system housed in a metallic box mounted on motor body, minimizing dimensions and optimizing wiring and mounting easiness.
- Target: advanced applications requiring the detection of motor loss of synchronism or stall by means of encoder and programmable motion controller setting by means of CANopen interface.
- UL/CSA certified versions available.

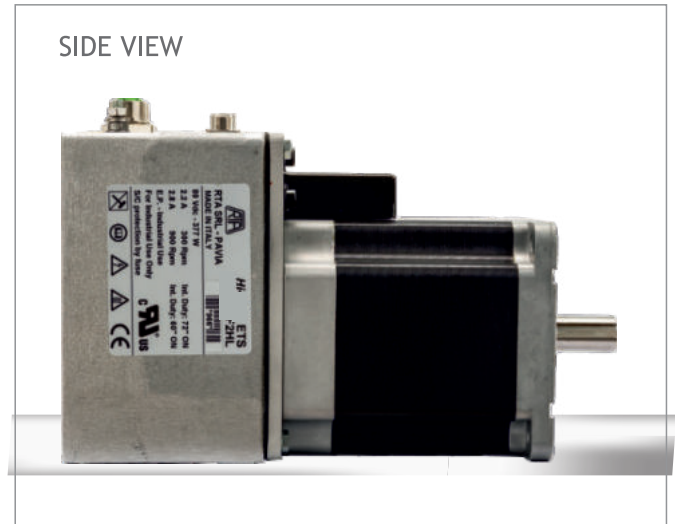

HIGHLIGHTS

- Communication by means of CANopen interface .
- Command to execute runs with position control to set: distance, direction, speed and acceleration.
- Command to execute zero research (HOMING).
- Incremental Encoder (HI-MOD E) or high resolution Battery-less Multi-Turn Absolute Encoder (HI-MOD A).
- The system does not need back-up battery to keep the information when shut down (HI-MODA).

Front Brake and/or Gearbox versions available

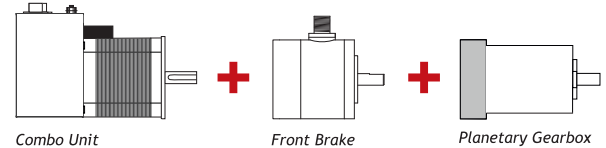

Models	Motor Length (mm)	Holding Torque (Ncm)	Encoder Type	Digital In/Out	UL Marking
HI-MOD A3F1H2	66.0	360	Battery-less Multi-turn Absolute	1/0	NO
HI-MOD A3F2H2	96.5	700	Battery-less Multi-turn Absolute	1/0	NO
HI-MOD A3F1H5	66.0	360	Battery-less Multi-turn Absolute	1/0	YES
HI-MOD A3F2H5	96.5	700	Battery-less Multi-turn Absolute	1/0	YES
HI-MOD E3F1H2	66.0	360	Incremental	1/0	NO
HI-MOD E3F2H2	96.5	700	Incremental	1/0	NO
HI-MOD E3F3H2	127.0	920	Incremental	1/0	NO
HI-MOD E3F1H5	66.0	360	Incremental	1/0	YES
HI-MOD E3F2H5	96.5	700	Incremental	1/0	YES
HI-MOD E3F3H5	127.0	920	Incremental	1/0	YES

SIZES AND PERFORMANCES

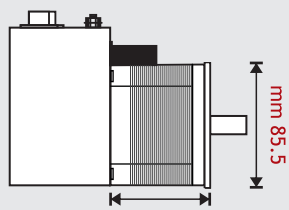

mm 66 (1H)

Holding Torque: 360 Ncm

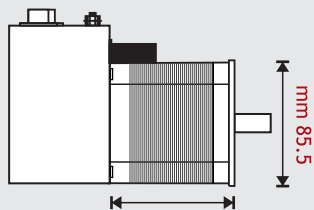

mm 96.5 (2H)

Holding Torque: 700 Ncm

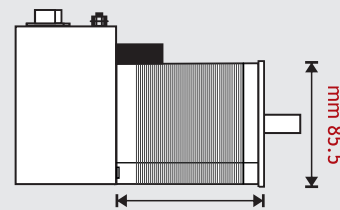

mm 127 (3H)

Holding Torque: 920 Ncm

CONNECTION SCHEME

CN1

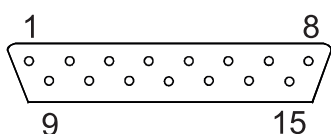

4-12: PX
7-8: Power Suppl
6-13-14-15: GND
5: + 24 Volt VDC

CN2



Male

CN3



Female

2: Positive control logic supply
3: Negative logic supply and negative CAN_H / CAN_L
4: CAN_H bus line
5: CAN_L bus line

TORQUE/SPEED CURVE

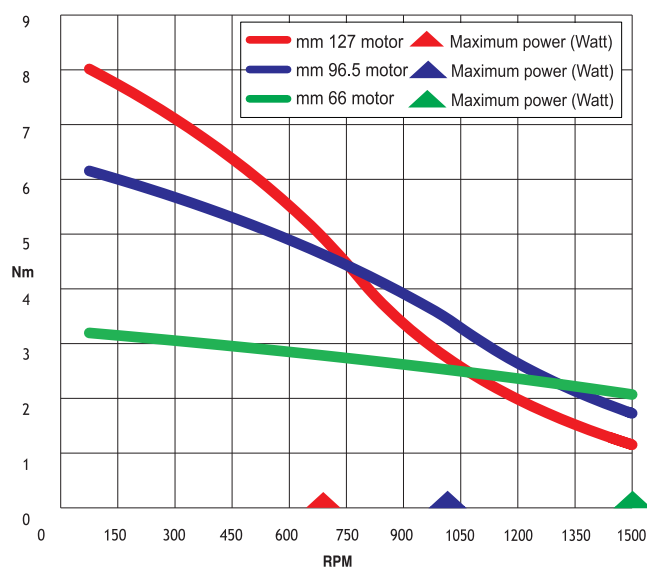

MECHANICAL DIMENSIONS (mm)

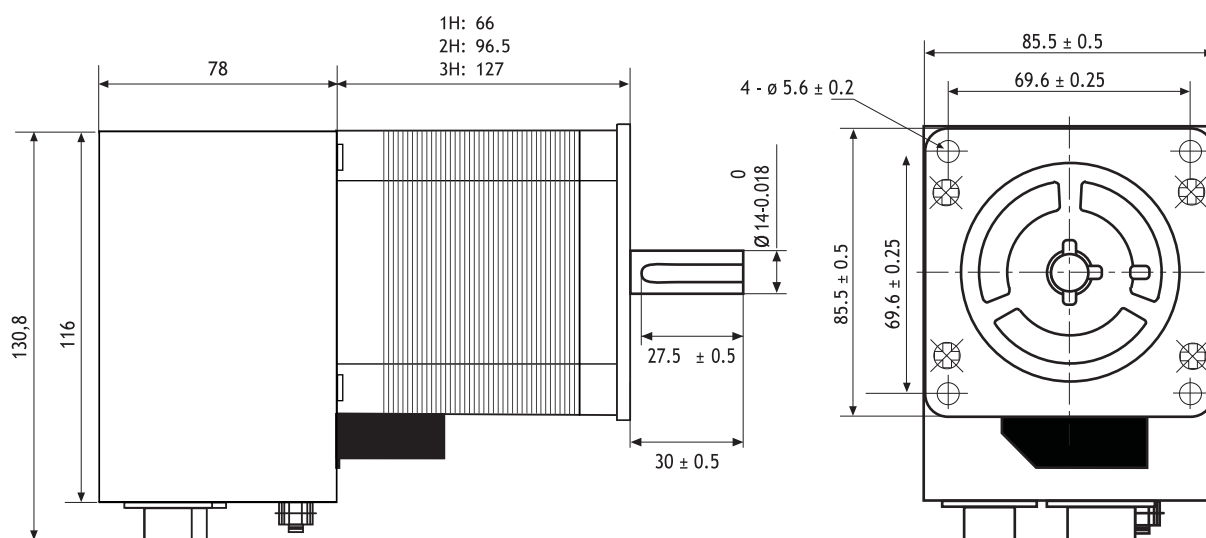

Starter kit and cable set available.



CANopen - NOT PREFERRED MODELS

	DRIVE TYPE	VOLTAGE RANGE (V)	PHASE CURRENT RANGE (A)	SUGGESTED MOTORS (Flange size)	CERTIFICATIONS	SUGGESTED MOTORS
HI-MOD B3F1H0.C	CO	32 - 75 VDC	//	//	CE	//
HI-MOD B3F2H0.C	CO	32 - 75 VDC	//	//	CE	//
HI-MOD B3F3H0.C	CO	32 - 75 VDC	//	//	CE	//

"Not preferred models" are models which have been replaced with the latest versions. They are still available in R.T.A.'s stock, however they are not recommended for new applications.

STEPPING MOTOR DRIVES

MODBUS TCP/IP



X-PLUS MT Series Drives

INTRODUCTION

- New series of stepping motor drives with Modbus interface, direct input from the main AC power supply and STO function.
- Direct connection from the main AC power supply (110 Vac to 230 Vac).
- Auto-sync function available featuring a closed loop positioning.
- Optimized for coupling with SANYO DENKI stepping motors, fitted with or without encoder.
- High performances in terms of power and ability to further increase the potential of the applications.
- UL/CSA certified.

HIGHLIGHTS

- Communication by means of Modbus TCP/IP interface.
- Modes of operation: PROFILE POSITION, PROFILE VELOCITY and HOMING
- Full digital microstepping drive.
- Wide range of SANYO DENKI stepping motors to be coupled with: holding torque up to 9,2 Nm and flange size up to 86 mm.
- Extremely compact size.
- A highly sophisticated operation system, preserving anyhow the traditional ease of use of R.T.A. drives.
- Configurable IP address via USB port
- Easy setup by RTA Modbus configurator software



Please refer to download.rta.it for technical specifications

STO FUNCTION FEATURES

- Safe Torque Off (STO) function - **SIL3**
- Error Detection Monitor

SIL3
SAFE TORQUE OFF (STO)

Series	Model	V _{AC} range (Volt)	I nom. (Amp)	Digital In/Out	STO In	Dimensions (mm)
X-PLUS MT	S4 STO	110 to 230 +/- 15%	4.0	4/3	2	169x129x46
X-PLUS MT	B4	110 to 230 +/- 15%	4.0	4/3	/	169x129x46

TECHNICAL FEATURES

- Communication by means of Modbus TCP/IP interface.
- Possibility to switch off motor current by means of STO function.
- Range of operating voltages: 110-230 V_{AC}.
- Protections:
 - Protection against under-voltage and over-voltage.
 - Protection against short-circuit at motor outputs.
 - Overtemperature protection.
- Electronic damping facility for further acoustic noise and mechanic vibrations reduction.
- Available in boxed version with plug-in connectors. Maximum compactness.
- Optoinsulated auxiliary and programmable inputs and outputs.
- External fans not needed.
- UL/CSA certified.
- Warranty: 24 months.
- Wide range of motor phase current setting.
- Motor current overboost (120%).
- Intelligent management of the current profile.
- Communication by means of Modbus (CoE) interface.
- Different variety of HOMING operation modes.
- Encoder feedback.

POWER AND LOGIC CONNECTIONS

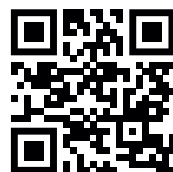
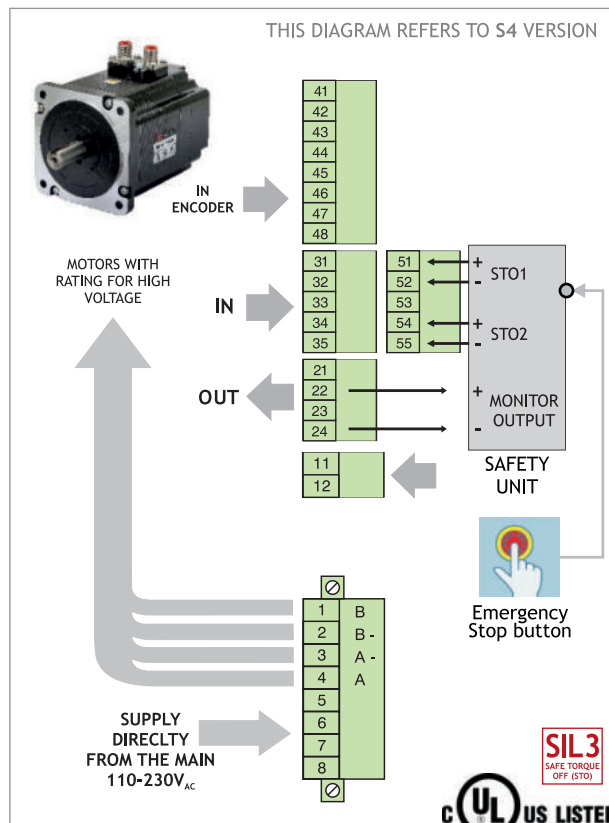

SCAN THE QR CODE TO WATCH A VIDEO ON THE AUTO-SYNC FUNCTION



MECHANICAL DIMENSIONS

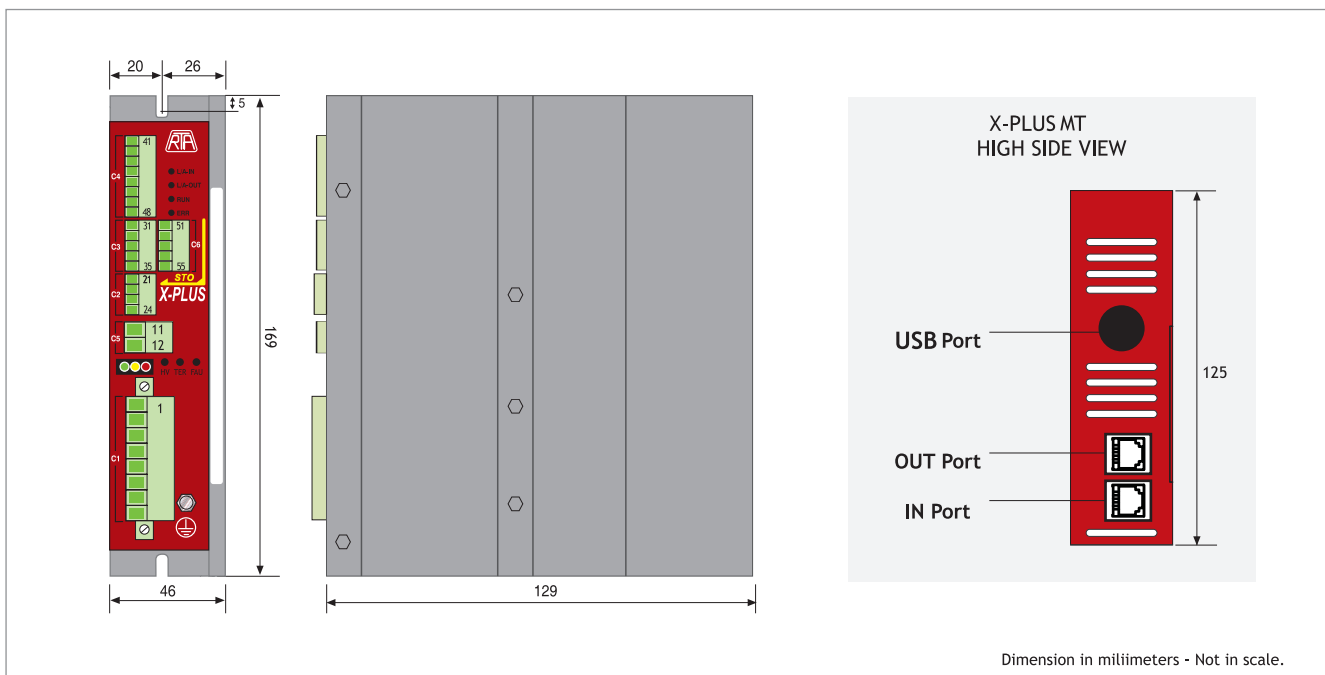

STEPPING MOTOR DRIVES

STEP/DIRECTION ADVANCED



BSD Series Drives

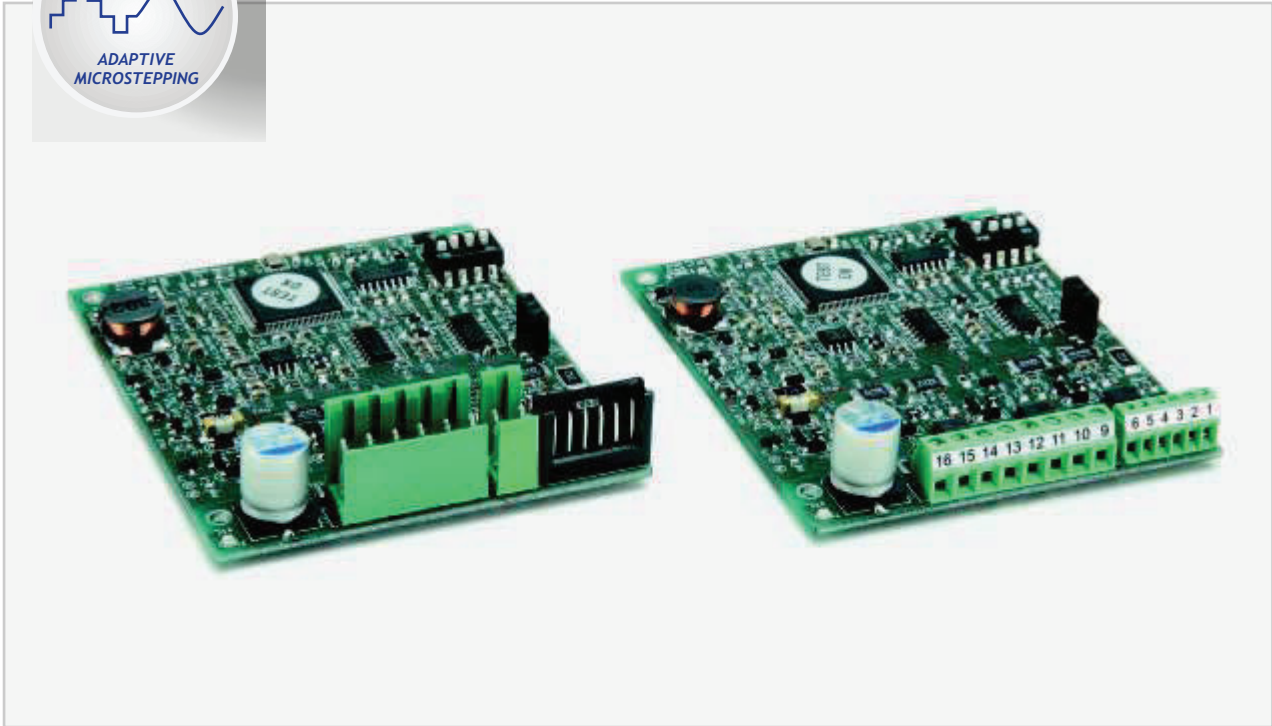
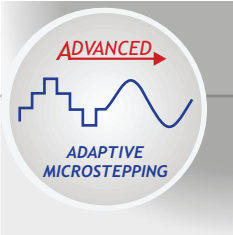

INTRODUCTION

- New series of microstep stepping motor drives specifically developed for small and mid-size stepping motors.
- Ultra-compact and optimized design to reduce space and cost, combined with *Adaptive Microstepping* technology ensuring noise and vibration suppression.
- Target: simple and effective motion control solutions requiring low power, high precision, smoothness of movement and low acoustic noise.
- Ideal solution to replace integrated circuits and self-made, low power drives. The perfect choice for small routers, medical, 3D printers and all types of compact machines.

HIGHLIGHTS

- Full digital microstepping drive.
- Adaptive microstepping up to 3.200 step/rev.
- Intelligent management of the current profile that achieves good results in terms of smoothness of movement, low noise and vibration control.
- A highly sophisticated control system, preserving anyhow the traditional ease of use of R.T.A. drives.

Series	Model	V _{DC} range (Volt)	I _{NP} min. (Peak value) (Amp)	I _{NP} max. (Peak value) (Amp)	Dimensions (mm)
BSD	02 - 02.V*	24 to 48	0.7	2.2	78x68x21

* BSD 02.V version is equipped with screw-type connectors.

TECHNICAL FEATURES

- Range of operating voltage: 24-48 V_{DC}.
- Range of current: 0.7-2.2 Amp. Setting up to four possible values by means of dip-switches.
- Microstepping: 400, 800, 1.600 and 3.200 steps/revolution. Setting by means of dip-switches.
- Automatic current reduction at motor standstill.
- Management of the current profile setting by means of a dip-switch.
- Protections:
 - Protection against under-voltage.
 - Protection against a short-circuit at motor outputs.
- Electronic damping facility for further acoustic noise and mechanic vibrations reduction.
- Available version: open frame, crimp-type/screw-type connectors.
- Maximum compactness.
- Warranty: 24 months.



POWER AND LOGIC CONNECTIONS

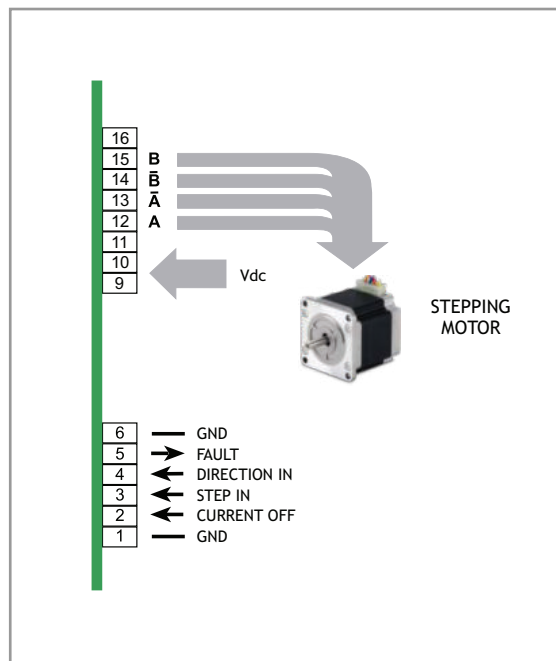

MECHANICAL DIMENSIONS

68
61.5
78
65.5
21

TRADITIONAL DRIVER

-30%!

BSD DRIVER

REAL DIMENSIONS

Dimensions in millimeters - In scale.

BSD 02.S Series Drives

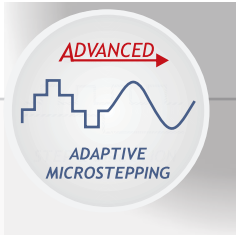

INTRODUCTION

- New series of microstep stepping motor drives specifically developed for small and mid-size stepping motors.
- Ultra-compact and optimized design to reduce space and cost, combined with *Adaptive Microstepping* technology ensuring noise and vibration suppression.
- Target: simple and effective motion control solutions requiring low power, high precision, smoothness of movement and low acoustic noise.
- Ideal solution to replace integrated circuits and self-made, low power drives. The perfect choice for small routers, medical, 3D printers and all types of compact machines.

HIGHLIGHTS

- Full digital microstepping drive.
- Adaptive microstepping up to 3.200 step/rev.
- Intelligent management of the current profile that achieves good results in terms of smoothness of movement, low noise and vibration control.
- Highly compact, easy to use and cost effective solution. This system is designed to be soldered to a PCB.
- A highly sophisticated control system, preserving anyhow the traditional ease of use of R.T.A. drives.

NEW VERSION EQUIPPED WITH SOLDER PINS (STRIPLINE)

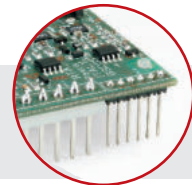

Series	Model	V _{DC} range (Volt)	I _{NP} min. (Peak value) (Amp)	I _{NP} max. (Peak value) (Amp)	Dimensions (mm)
BSD	02.S	24 to 48	0.7	2.2	78x68x27

TECHNICAL FEATURES

- Range of operating voltage: 24-48 V_{DC}.
- Range of current: 0.7-2.2 Amp. Setting up to four possible values by means of dip-switches.
- Microstepping: 400, 800, 1.600 and 3.200 steps/revolution. Setting by means of dip-switches.
- Automatic current reduction at motor standstill.
- Management of the current profile setting by means of a dip-switch.
- Protections:
 - Protection against under-voltage.
 - Protection against a short-circuit at motor outputs.
- Electronic damping facility for further acoustic noise and mechanic vibrations reduction.
- Available version: open frame, crimp-type/screw-type/solder pin connectors. Maximum compactness.
- Warranty: 24 months.



POWER AND LOGIC CONNECTIONS

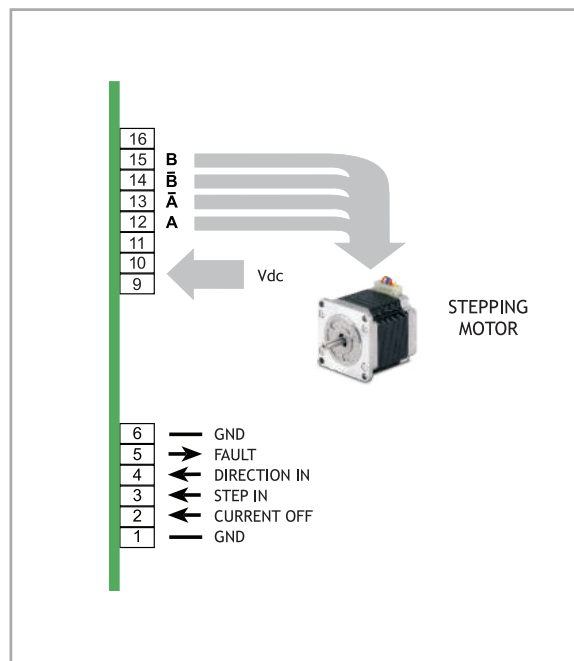

MECHANICAL DIMENSIONS

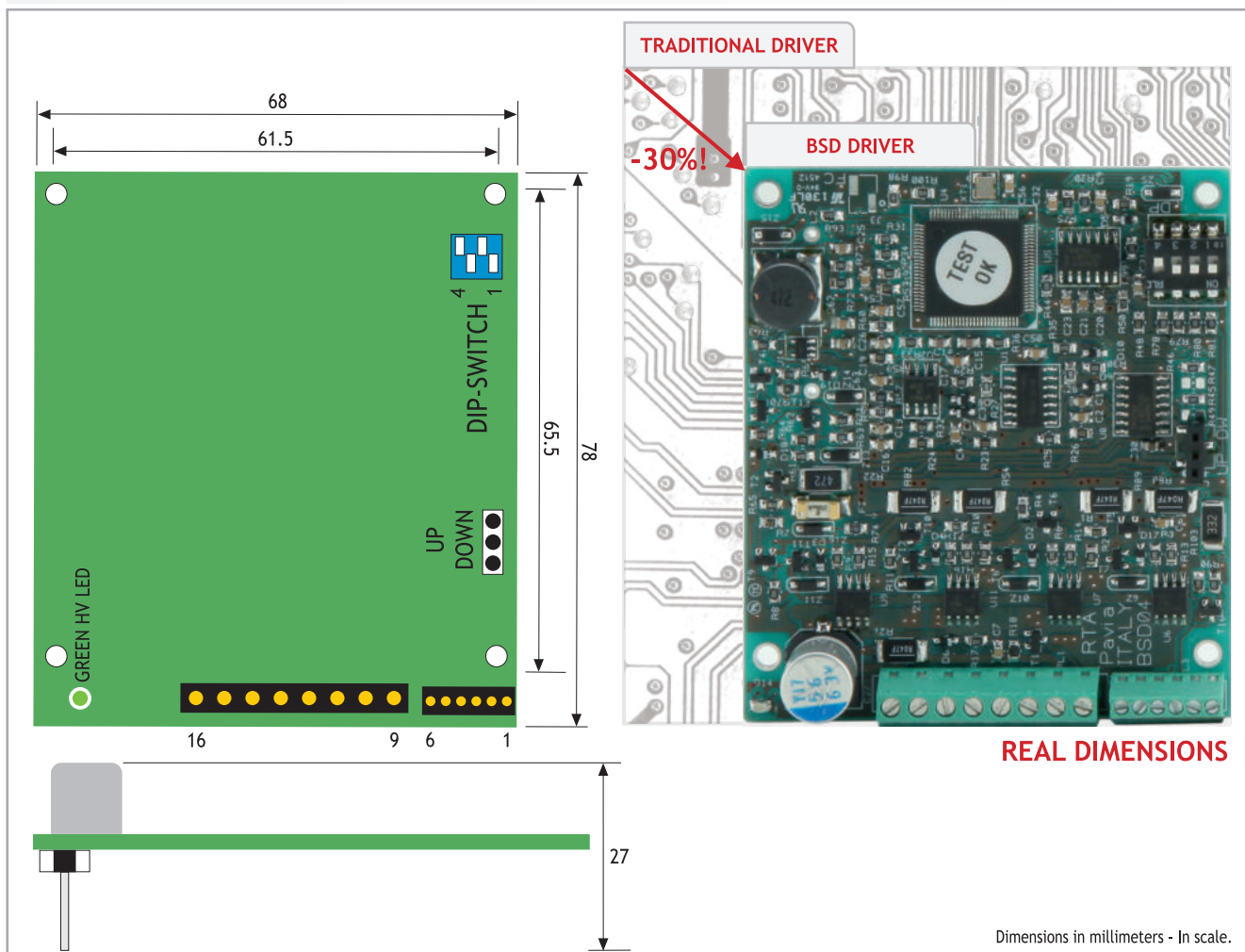

A-CSD Series Drives

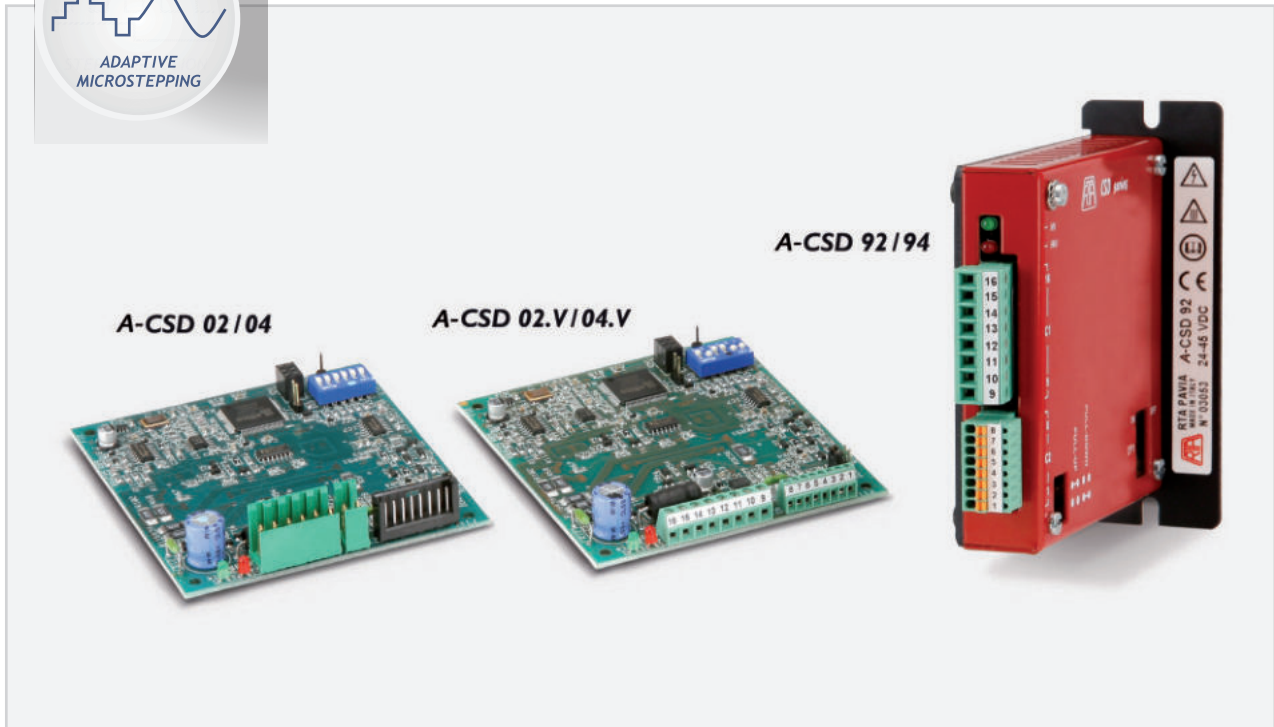
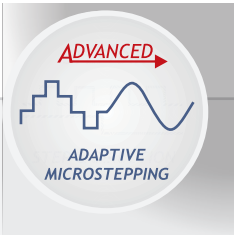

INTRODUCTION

- New series of bipolar microstep stepping motor drives, specifically developed for applications sensitive to acoustic noise and vibration.
- Significant evolution of the CSD series, preserving backward mechanical, electrical and applicative compatibility.
- Target: advanced applications requiring high precision, smoothness of movement and low acoustic noise.

HIGHLIGHTS

- Full digital microstepping drive.
- Adaptive microstepping up to a 3.200 step/rev.
- Intelligent management of the current profile that achieves good results in terms of smoothness of movement, low noise and vibration control.
- A highly sophisticated control system, preserving anyhow the traditional ease of use of R.T.A. drives.

Series	Model	V _{DC} range (Volt)	I _{NP} min. (Peak value) (Amp)	I _{NP} max. (Peak value) (Amp)	Dimensions (mm)
A-CSD	02 - 02.V*	24 to 48	0.7	2.4	92x85x22
A-CSD	04 - 04.V*	24 to 48	2.6	4.4	92x85x23
A-CSD	92	24 to 48	0.7	2.4	99x90x21
A-CSD	94	24 to 48	2.6	4.4	99x90x21

* A-CSD 02.V and A-CSD 04.V versions are equipped with screw-type connectors.

TECHNICAL FEATURES

- Range of operating voltage: 24-48 V_{DC}.
- Range of current: 0.7-4.4 Amp. Setting up to eight possible values by means of dip-switches.
- Microstepping: 400, 800, 1.600 and 3.200 steps/revolution. Setting by means of dip-switches.
- Automatic current reduction at motor standstill.
- Management of the current profile setting by means of a dip-switch.
- Protections:
 - Protection against under-voltage and over-voltage.
 - Protection against a short-circuit at motor outputs.
 - Overtemperature protection with thermal sensor.
- Electronic damping facility for further acoustic noise and mechanic vibrations reduction.
- Available versions: boxed/open frame, crimp-type/screw-type connectors. Maximum compactness.
- Warranty: 24 months.



POWER AND LOGIC CONNECTIONS

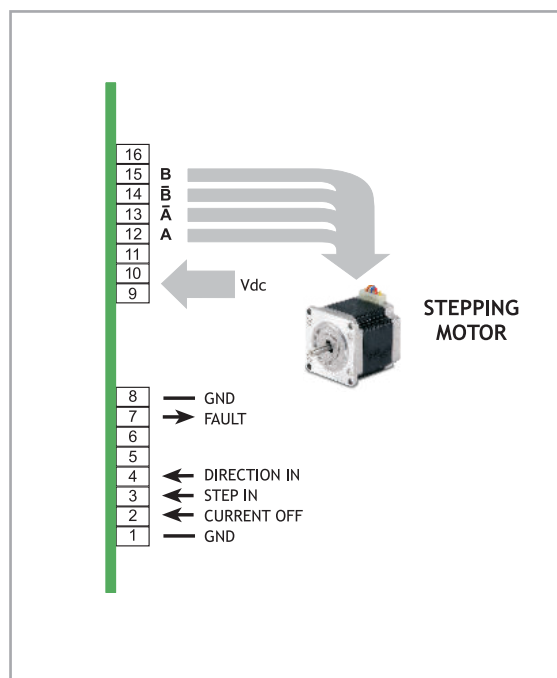

A-CSD is included in KIT CNC 02, a complete 48 VDC motion solution, designed for 3-axes CNC Router machines.

FIND OUT MORE



MECHANICAL DIMENSIONS

A-CSD 02 / A-CSD 04

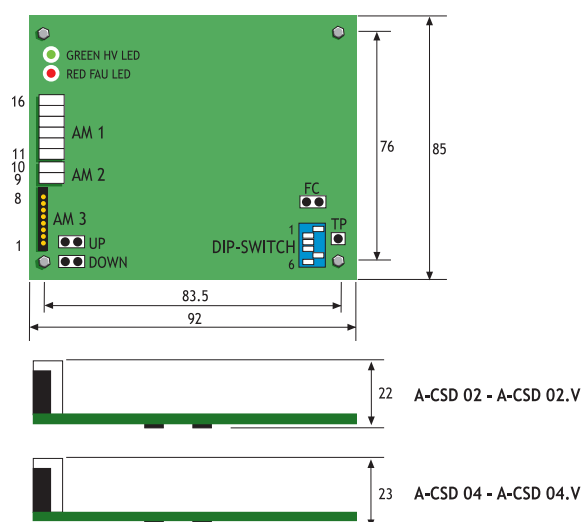

A-CSD 92 / A-CSD 94

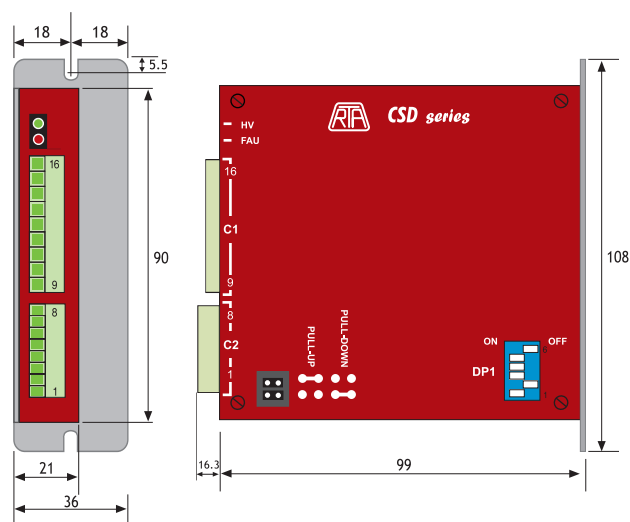

Dimensions in millimeters - Not in scale.

HGD Series Drives

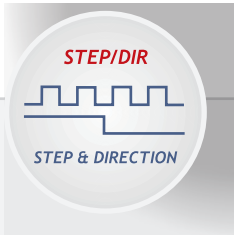

INTRODUCTION

- Series of ministep bipolar chopper drives, suitable for driving medium power two-phase stepping motors, with four, six or eight terminals.
- Highly compact (70×70×25 mm), easy to use and cost effective solution. This system is designed to be soldered to a PCB.
- Target: medium and medium-low power applications requiring increase in performance compared to self-built or integrated circuits combined with an improvement of reliability and durability.

HIGHLIGHTS

- Microstepping function up to 3.200 step/rev.
- Separated solder type connectors for logic signals and power connections.
- Electronic damping facility for further acoustic noise and mechanic vibrations reduction at low and medium speed.
- Standard input and output signals ease interfacing with the most commonly used control systems and ensure high noise immunity.

Series	Model	V _{DC} range (Volt)	I _{NP} min. (Peak value) (Amp)	I _{NP} max. (Peak value) (Amp)	Dimensions (mm)
HGD	02	24 to 75	0.75	2.0	70x70x25
HGD	05	24 to 75	2.25	6.0	70x70x25

TECHNICAL FEATURES

- Range of operating voltages: 24-75 V_{DC}.
Operation with a single external supply voltage.
- Range of current: 0.75-6.0 Amp. Setting up to six possible values by means of hardware connections.
- Microstepping: 400, 800, 1.600 and 3.200 steps /revolution.
Setting by means of hardware connections.
- Automatic current reduction at motor standstill.
- Protections:
 - Protection against under-voltage and over-voltage.
 - Protection against a short-circuit at motor outputs.
 - Overtemperature protection.
- Possibility to reduce motor current with an external logic signal.
- High efficiency CHOPPER with MOSFET final stage output.
- Electronic damping facility for further acoustic noise and mechanic vibrations reduction at low and medium speed.
- Warranty: 24 months.



MECHANICAL DIMENSIONS

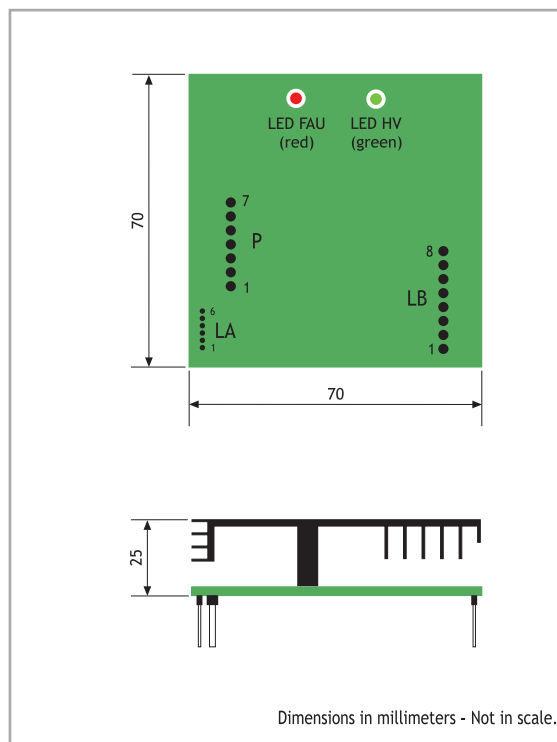

POWER AND LOGIC CONNECTIONS

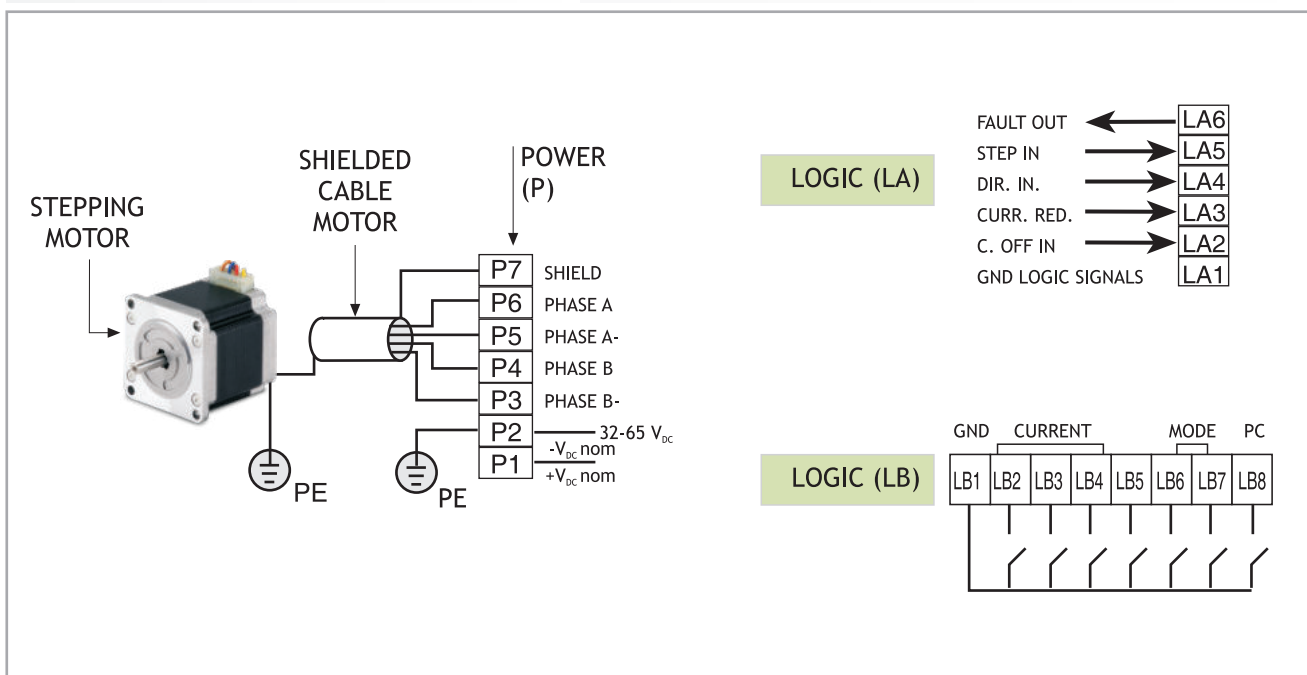

A-NDC Series Drives

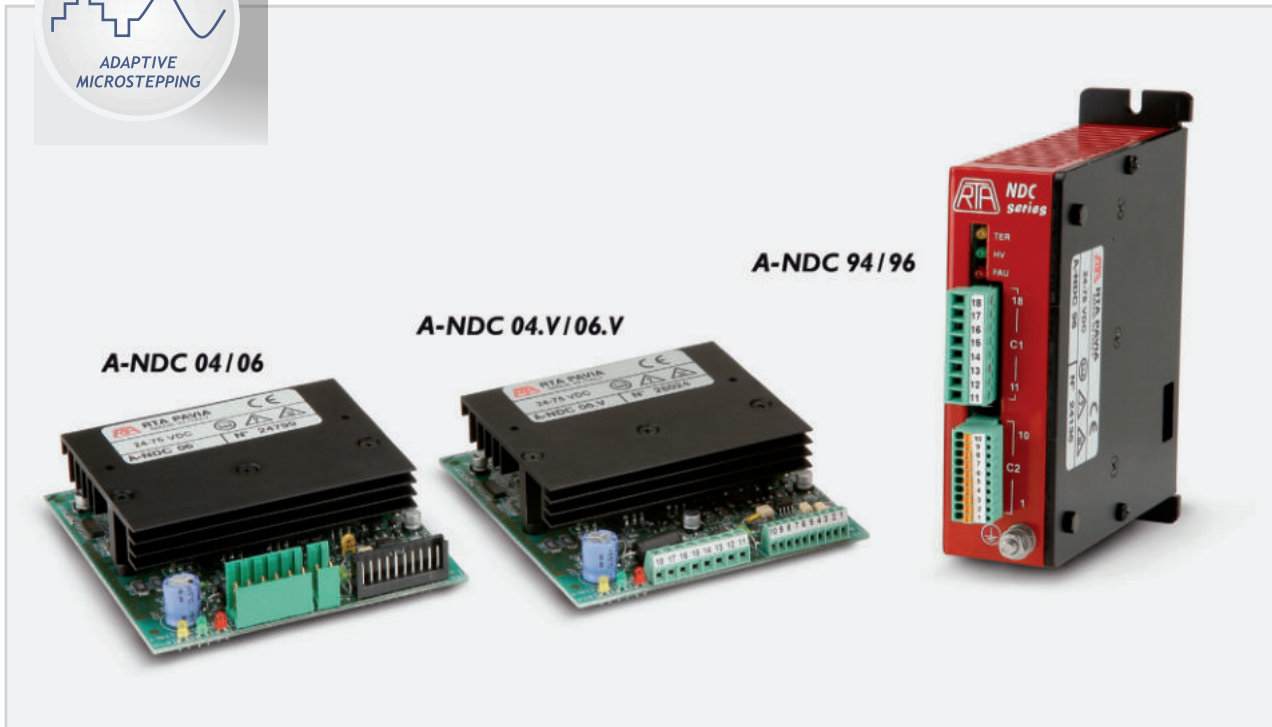
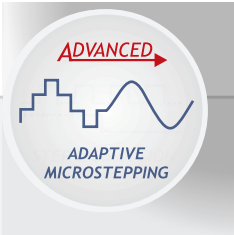

INTRODUCTION

- New series of bipolar microstep stepping motor drives, specifically developed for applications sensitive to acoustic noise and vibration.
- Significant evolution of the NDC series, preserving backward mechanical, electrical and applicative compatibility.
- Target: advanced applications requiring high precision, smoothness of movement and low acoustic noise.

HIGHLIGHTS

- Full digital microstepping drive.
- Adaptive microstepping up to a 12.800 step/rev (1/64).
- Intelligent management of the current profile that achieves good results in terms of smoothness of movement, low noise and vibration control.
- A highly sophisticated control system, preserving anyhow the traditional ease of use of R.T.A. drives.

Series	Model	V _{DC} range (Volt)	I _{NP} min. (Peak value) (Amp)	I _{NP} max. (Peak value) (Amp)	Dimensions (mm)
A-NDC	04 - 04.V*	24 to 85	0.6	2.0	101x94x25
A-NDC	06 - 06.V*	24 to 85	1.9	6.0	101x94x25
A-NDC	94	24 to 85	0.6	2.0	110x108x34
A-NDC	96	24 to 85	1.9	6.0	110x108x34

* A-NDC 04.V and A-NDC 06.V versions are equipped with screw-type connectors.

TECHNICAL FEATURES

- Range of operating voltage: 24-85 V_{DC}.
- Range of current: 0.6-6 Amp. Setting up to eight possible values by means of dip-switches.
- Microstepping: 400, 800, 1.600, 3.200, 6.400 and 12.800 steps/revolution. Setting by means of dip-switches.
- Automatic current reduction at motor standstill.
- Management of the current profile setting by means of a dip-switch.
- Protections:
 - Protection against under-voltage and over-voltage.
 - Protection against a short-circuit at motor outputs.
 - Overtemperature protection with thermal sensor.
- Electronic damping facility for further acoustic noise and mechanic vibrations reduction.
- Available versions: boxed/open frame, crimp-type/screw-type connectors. Maximum compactness.
- Optoinsulated inputs to ensure best EM noise immunity.
- Warranty: 24 months.



POWER AND LOGIC CONNECTIONS

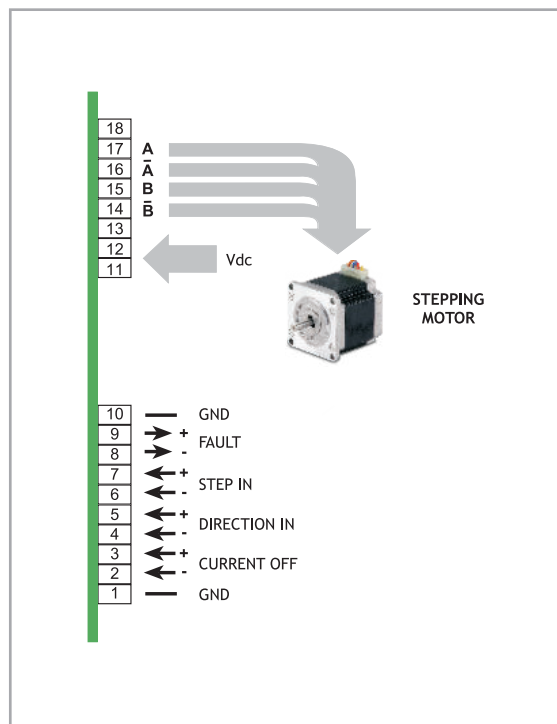

MECHANICAL DIMENSIONS

A-NDC 04 / A-NDC 06

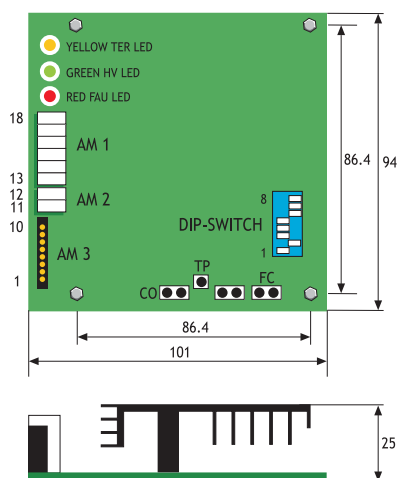

A-NDC 94 / A-NDC 96

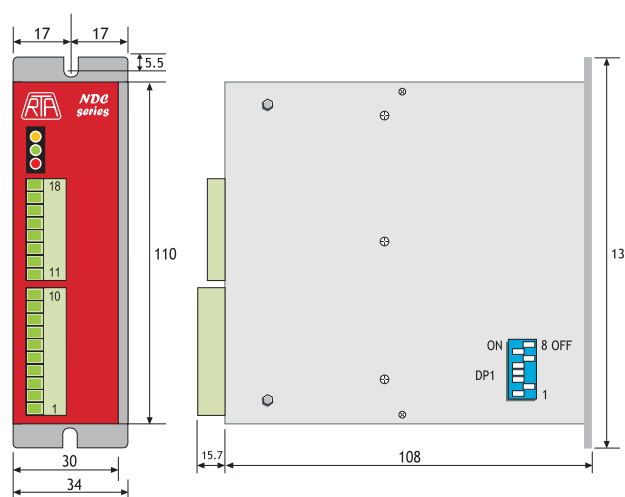

Dimensions in millimeters - Not in scale.



X-PLUS L Series Drives

INTRODUCTION

- New series of compact bipolar microstep stepping motor drive with power input directly from the main AC supply (110 VAC to 230 VAC), specifically developed for Nema 23 and Nema 34 single stack motor coupling.
- The drive is equipped with an internal rectifier able to transfer more than 300 VDC (230 VAC) to the motor, in order to ensure the maximum power for the applications as well as a significant cost saving on transformer and rectifier, together with related cabling.
- Ten years after the development of X-PLUS B4 (230 VAC, 4 Amp) X-PLUS L2 features a more compact and economically competitive solution especially developed for small size motors.

HIGHLIGHTS

- Full digital microstepping drive.
- Adaptive microstepping up to 4000 step/rev.
- Intelligent management of the current profile that achieves good results in terms of smoothness of movement, low noise and vibration control.
- A highly sophisticated control system, preserving anyhow the traditional ease of use R.T.A. drives.
- Mandatory coupling with stepper motors rated for high voltage (class F insulation), from NEMA 23 single stack up to, at max, NEMA 34 single stack.

ONE OF THE MOST COMPACT DRIVES WITH POWER INPUT DIRECTLY FROM THE MAIN AC SUPPLY (110 - 230 VAC)

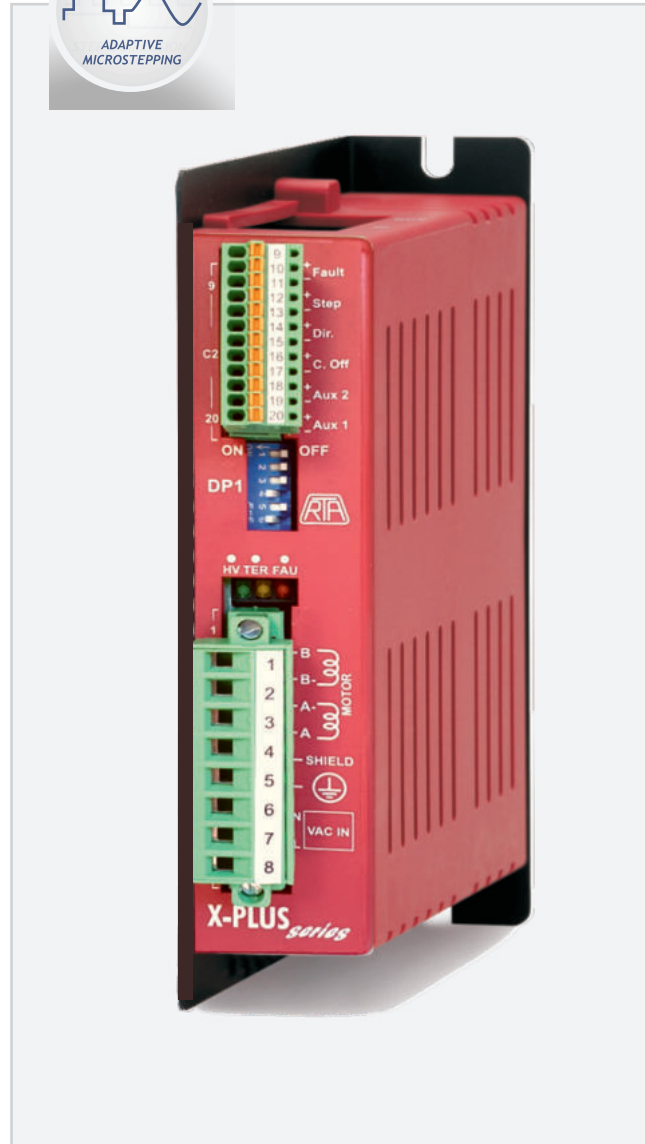
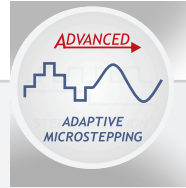

X-PLUS L2 is included in KIT CNC 01, a complete 230 VAC motion solution, designed for 3-axes CNC Router machines.

FIND OUT MORE



Series	Model	V _{AC} range (Volt)	I _{NP} min. (Peak value) (A)	I _{NP} max. (Peak value) (A)	Dimensions (mm)
X-PLUS	L2	110 to 230 +/- 15%	1.4	2.5	152x129x30

TECHNICAL FEATURES

- Range of operating voltages: 110-230 VAC.
- Range of current: 1.4 - 2.5 A. Setting up four possible values by means of dip-switches.
- Microstepping: 400, 800, 1.600, 3.200 and 500, 1.000, 2.000, 4.000 steps/revolution. Setting by means of dip-switches.
- Automatic current reduction at motor standstill.
- Management of the current profile setting by means of a dip switch.
- Protections:
 - Protection against under-voltage and over voltage.
 - Protection against a short-circuit at motor outputs.
 - Overtemperature protection with thermal sensor.
- Optoinsulated inputs to ensure best EM noise immunity.
- Possibility to switch off motor current with an external logic signal.
- High efficiency CHOPPER.
- Electronic resonance damping circuit to ensure acoustic noise and mechanic vibrations reductions at low and medium speed.
- Alarm memory.
- External fans not needed.
- Coupling with stepping motors rated for high voltage.
- Warranty: 24 months.

POWER AND LOGIC CONNECTIONS

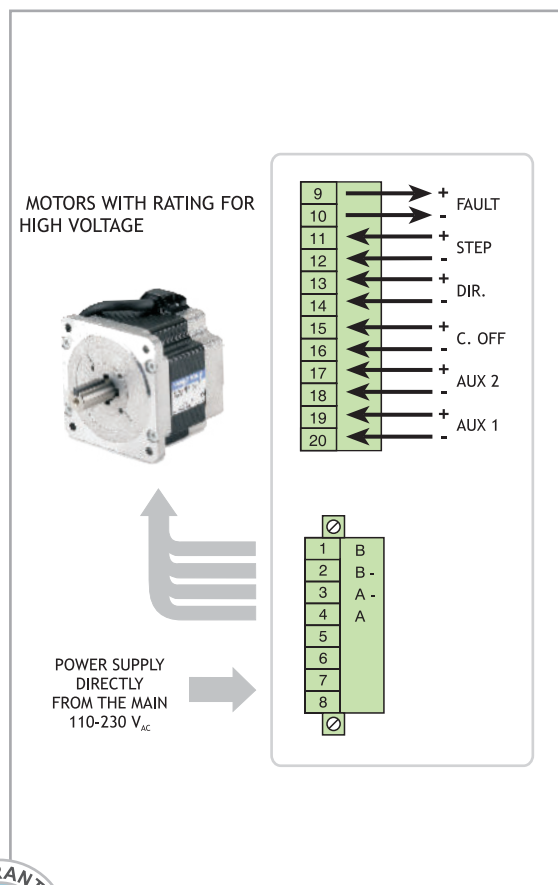

MECHANICAL DIMENSIONS

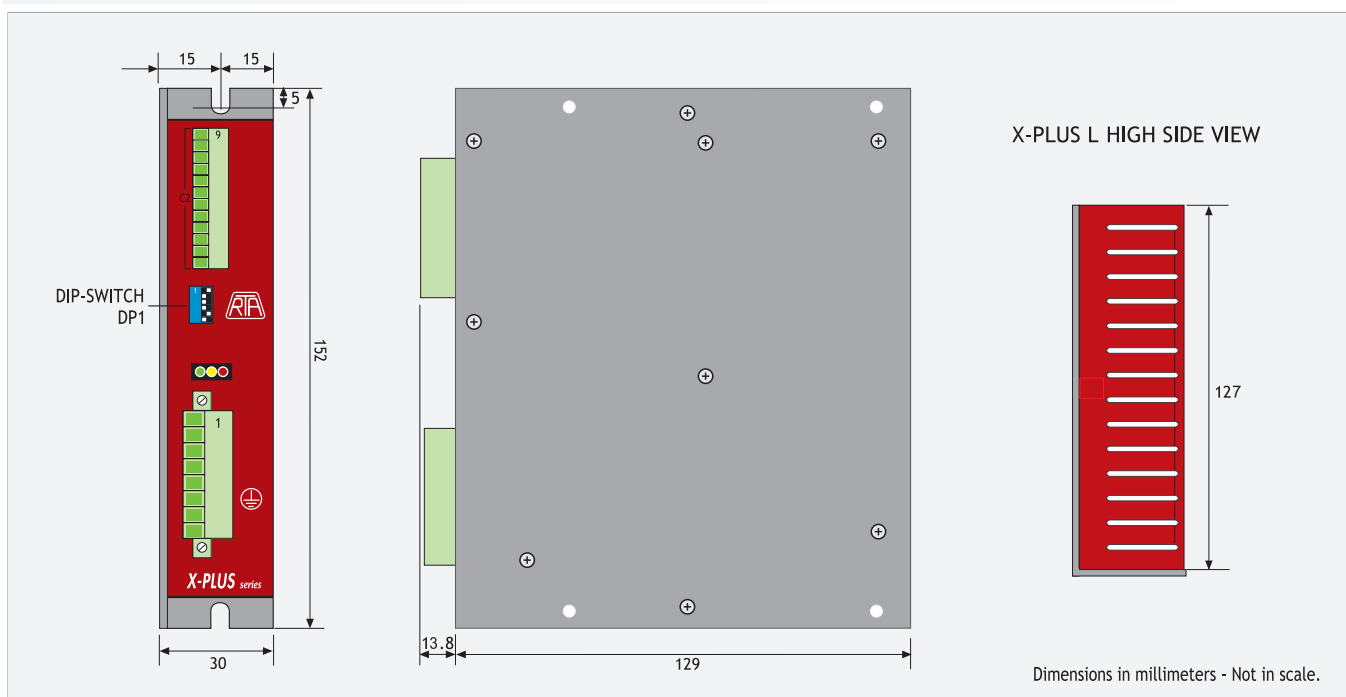

X-PLUS B4.1 Series Drives

INTRODUCTION

- New series bipolar microstep stepping motor drive with power input directly from the main AC supply (110 V_{AC} to 230 V_{AC}), specifically developed for applications requiring high performance with reduced acoustic noise and low vibrations.
- Target: advanced applications requiring high precision, low noise and smoothness of movement.
- The perfect choice for combining high power and low acoustic noise.

HIGHLIGHTS

- Full digital microstepping drive.
- Adaptive microstepping up to 3,200 step/rev.
- Intelligent management of the current profile that achieves good results in terms of smoothness of movement, low noise and vibration control.
- A highly sophisticated control system, preserving anyhow the traditional ease of use of R.T.A. drives.



ONE OF THE MOST COMPACT DRIVES WITH POWER INPUT DIRECTLY FROM THE MAIN AC SUPPLY (110 - 230 VAC)

Series	Model	V _{AC} range (Volt)	I _{NP} min. (Peak value) (Amp)	I _{NP} max. (Peak value) (Amp)	Dimensions (mm)
X-PLUS	B4.1	110 to 230 +/- 15%	2.4	4.0	152x129x46

TECHNICAL FEATURES

- Range of operating voltage: 110-230 V_{AC}.
- Range of current: 2.4-4 Amp. Setting up to four possible values by means of dip-switches.
- Microstepping: 400, 800, 1,600 and 3,200 steps/revolution. Setting by means of dip-switches.
- Automatic current reduction at motor standstill.
- Management of the current profile setting by means of a dip-switch.
- Protections:
 - Protection against under-voltage and over-voltage.
 - Protection against a short-circuit at motor outputs.
 - Overtemperature protection with thermal sensor.
- Electronic damping facility for further acoustic noise and mechanic vibrations reduction.
- Available in boxed version with plug-in connectors. Maximum compactness.
- Optoinsulated inputs to ensure best EM noise immunity.
- External fans not needed.
- Coupling with stepping motors rated for high voltage and equivalent or bigger than NEMA 34 is mandatory.
- Warranty: 24 months.



POWER AND LOGIC CONNECTIONS

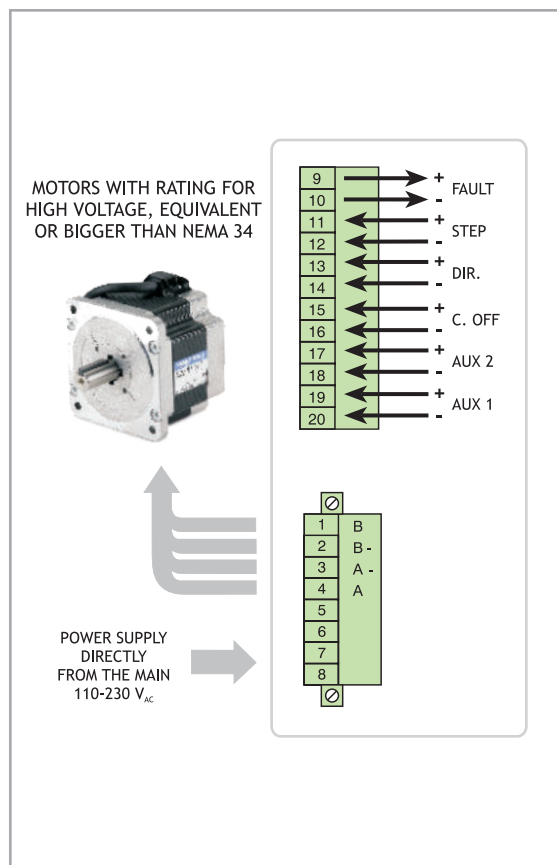

MECHANICAL DIMENSIONS

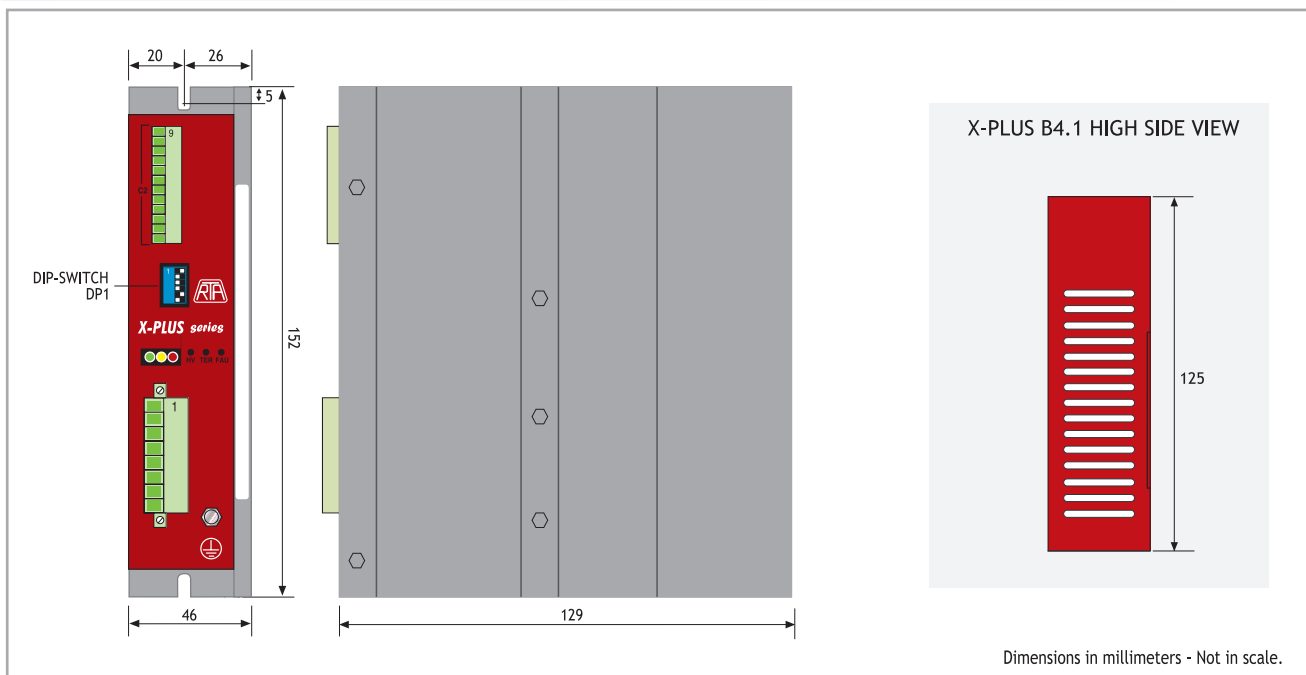



X-PLUS S4.1 Series Drives

INTRODUCTION

- New series bipolar microstep stepping motor drive with power input directly from the main AC supply (110 V_{AC} to 230 V_{AC}), with STO function, specifically developed for applications requiring high performance with reduced acoustic noise and low vibrations.
- Target: advanced applications requiring high precision, low noise and smoothness of movement.
- The perfect choice for combining high power and low acoustic noise.
- UL/CSA certified.

HIGHLIGHTS

- STO [SIL3] function.
- Error Detection Monitor.
- Full digital microstepping drive.
- Adaptive microstepping up to 3,200 step/rev.
- Intelligent management of the current profile that achieves good results in terms of smoothness of movement, low noise and vibration control.
- A highly sophisticated control system, preserving anyhow the traditional ease of use of R.T.A. drives.



STO FUNCTION FEATURES

- Safe Torque Off (STO) function - **SIL3**
- Error Detection Monitor



Series	Model	V _{AC} range (Volt)	I _{NP} min. (Peak value) (Amp)	I _{NP} max. (Peak value) (Amp)	Dimensions (mm)
X-PLUS	S4.1	110 to 230 +/- 15%	2.4	4.0	152x129x46

TECHNICAL FEATURES

- Possibility to switch off motor current by means of STO function.
- Range of operating voltages: 110-230 V_{AC}.
- Range of current: 2.4-4.0 Amp. Setting up to four possible values by means of dip-switches.
- Microstepping: 400, 800, 1.600, 3.200 steps /revolution. Setting by means of dip-switches.
- Automatic current reduction at motor standstill.
- Protections:
 - Protection against under-voltage and over-voltage.
 - Protection against a short-circuit at motor outputs.
 - Overtemperature protection.
- Electronic damping facility for further acoustic noise and mechanic vibrations reduction.
- Available in boxed version with plug-in connectors. Maximum compactness.
- Optoinsulated inputs to ensure best EM noise immunity.
- External fans not needed.
- Coupling with stepping motors rated for high voltage and equivalent or bigger than NEMA 34 is mandatory.
- UL/CSA certified.
- Warranty: 24 months.

POWER AND LOGIC CONNECTIONS

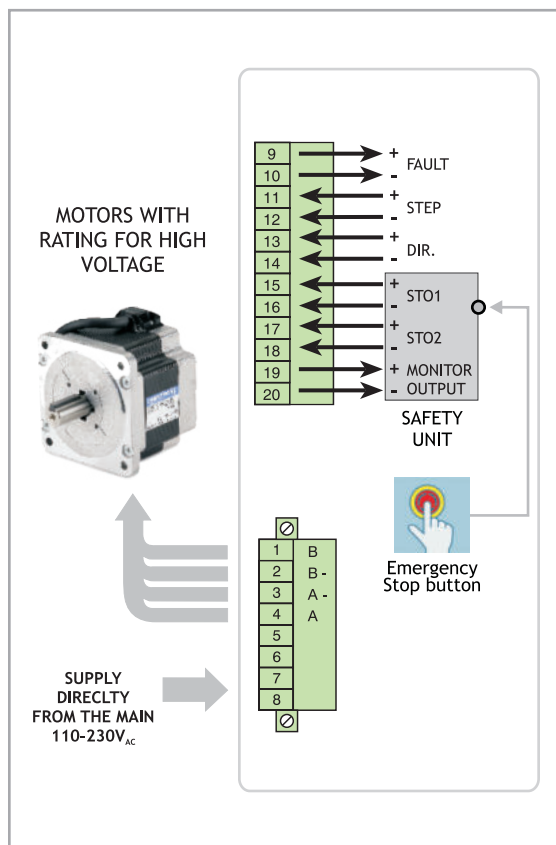

STO FUNCTION FEATURES

- Safe Torque Off (STO) function [SIL3]
- Error Detection Monitor

SIL3
SAFE TORQUE OFF (STO)



INGOMBRI MECCANICI

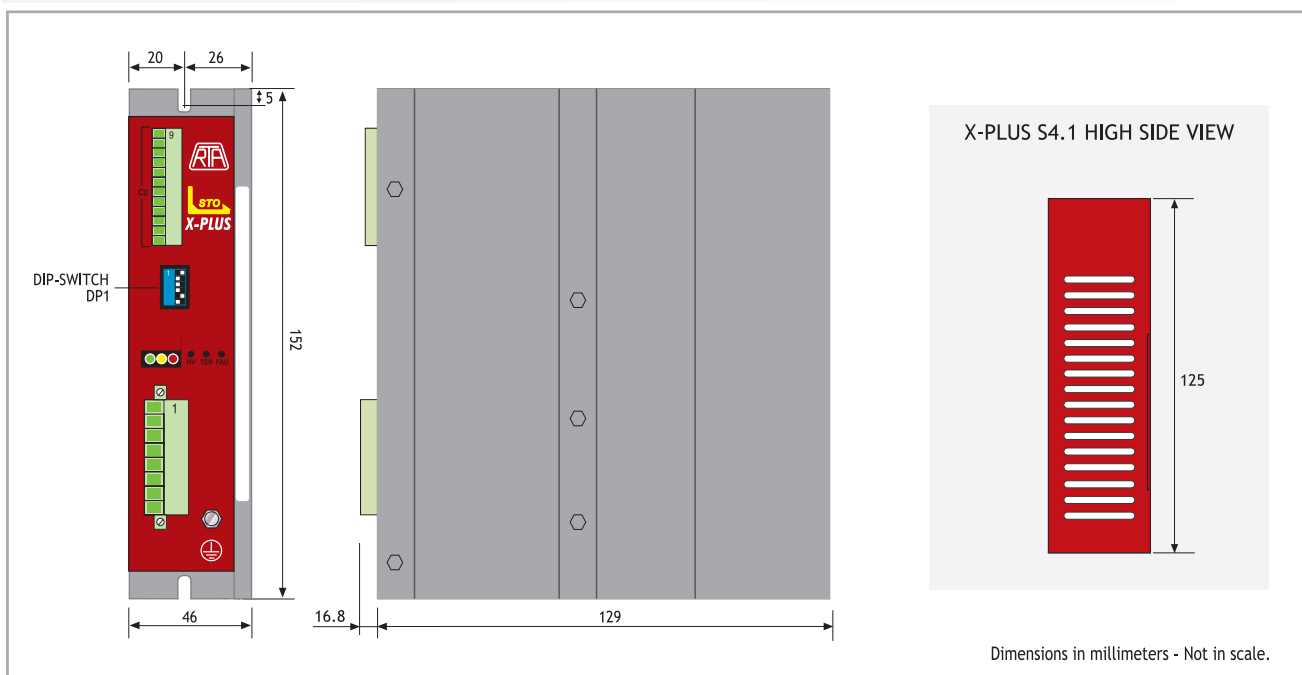



X-PLUS C4.1 Series Drives

INTRODUCTION

- New series bipolar microstep stepping motor drive with power input directly from the main AC supply (110 V_{AC} to 230 V_{AC}), specifically developed for applications requiring high performance with reduced acoustic noise and low vibrations .
- Target: advanced applications requiring high precision, low noise and smoothness of movement.
- The perfect choice for combining high power and low acoustic noise.
- UL/CSA certified.

HIGHLIGHTS

- Full digital microstepping drive.
- Adaptive microstepping up to 3,200 step/rev.
- Intelligent management of the current profile that achieves good results in terms of smoothness of movement, low noise and vibration control.
- A highly sophisticated control system, preserving anyhow the traditional ease of use of R.T.A. drives.

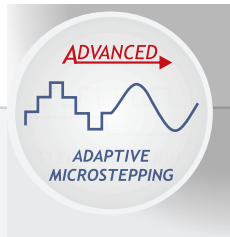

ONE OF THE MOST COMPACT DRIVES WITH POWER INPUT DIRECTLY FROM THE MAIN AC SUPPLY (110 - 230 VAC)

Series	Model	V _{AC} range (Volt)	I _{NP} min. (Peak value) (Amp)	I _{NP} max. (Peak value) (Amp)	Dimensions (mm)
X-PLUS	C4.1	110 to 230 +/- 15%	2.4	4.0	152x129x46

TECHNICAL FEATURES

- Range of operating voltage: 110-230 V_{AC}.
- Range of current: 2.4-4 Amp. Setting up to four possible values by means of dip-switches.
- Microstepping: 400, 800, 1,600 and 3,200 steps/revolution. Setting by means of dip-switches.
- Automatic current reduction at motor standstill.
- Management of the current profile setting by means of a dip-switch.
- Protections:
 - Protection against under-voltage and over-voltage.
 - Protection against a short-circuit at motor outputs.
 - Overtemperature protection with thermal sensor.
- Electronic damping facility for further acoustic noise and mechanic vibrations reduction.
- Available in boxed version with plug-in connectors. Maximum compactness.
- Optoinsulated inputs to ensure best EM noise immunity.
- External fans not needed.
- Coupling with stepping motors rated for high voltage and equivalent or bigger than NEMA 34 is mandatory.
- UL/CSA certified.
- Warranty: 24 months.



POWER AND LOGIC CONNECTIONS

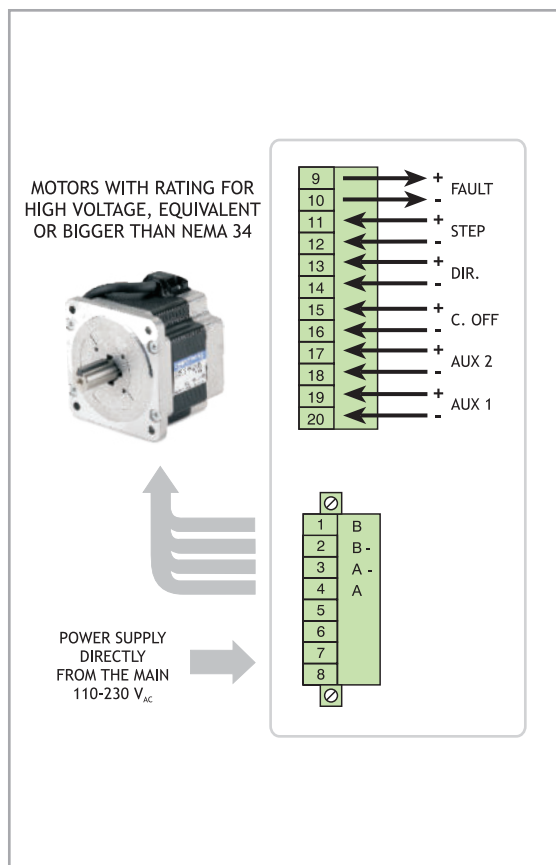

MECHANICAL DIMENSIONS

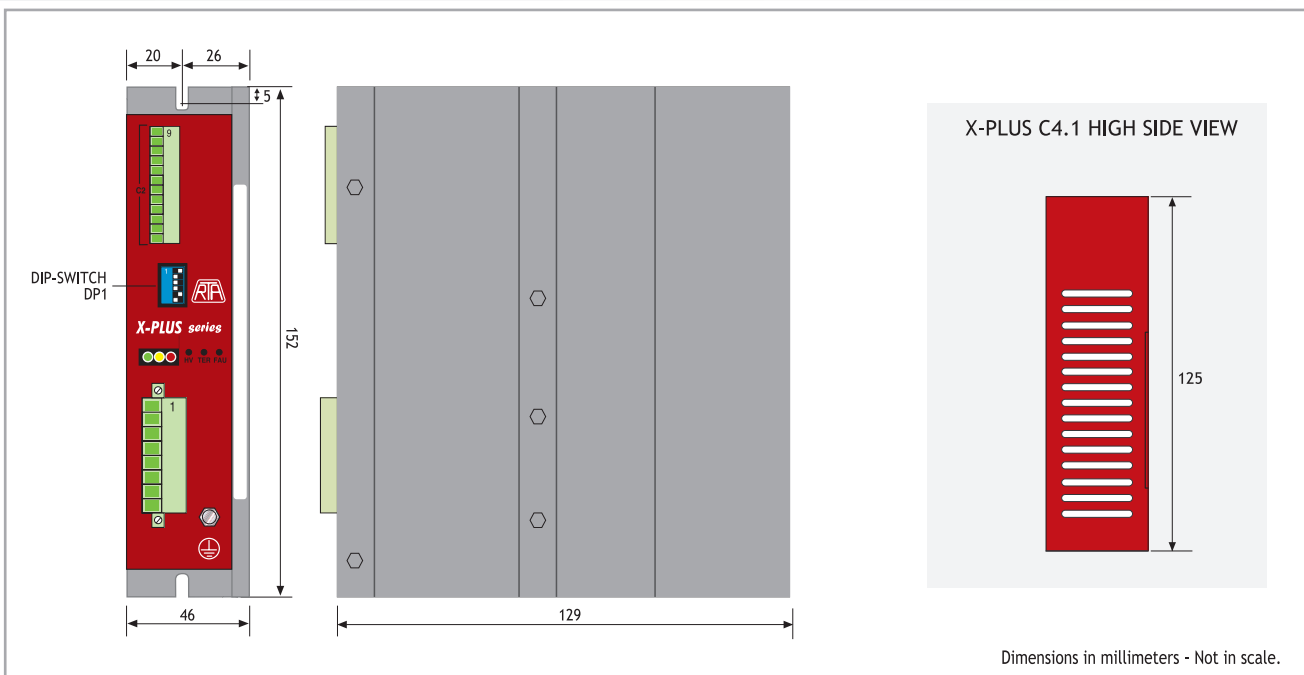

STEP & DIRECTION - NOT PREFERRED MODELS

	DRIVE TYPE	VOLTAGE RANGE (V)	PHASE CURRENT RANGE (A)	SUGGESTED MOTORS (Flange size)
CSD 02	STEP / DIR	24 - 48 VDC	0.7 - 2.4	NEMA 11, NEMA 17, NEMA 23, 60 mm
CSD 02.V	STEP / DIR	24 - 48 VDC	0.7 - 2.4	NEMA 11, NEMA 17, NEMA 23, 60 mm
CSD 04	STEP / DIR	24 - 48 VDC	2.6 - 4.4	NEMA 11, NEMA 17, NEMA 23, 60 mm
CSD 04.V	STEP / DIR	24 - 48 VDC	2.6 - 4.4	NEMA 11, NEMA 17, NEMA 23, 60 mm
CSD12	STEP / DIR	24 - 48 VDC	0.7 - 2.4	NEMA 11, NEMA 17, NEMA 23, 60 mm
CSD12.V	STEP / DIR	24 - 48 VDC	0.7 - 2.4	NEMA 11, NEMA 17, NEMA 23, 60 mm
CSD14	STEP / DIR	24 - 48 VDC	2.6 - 4.4	NEMA 11, NEMA 17, NEMA 23, 60 mm
CSD14.V	STEP / DIR	24 - 48 VDC	2.6 - 4.4	NEMA 11, NEMA 17, NEMA 23, 60 mm
CSD 92	STEP / DIR	24 - 48 VDC	0.7 - 2.4	NEMA 11, NEMA 17, NEMA 23, 60 mm
CSD 94	STEP / DIR	24 - 48 VDC	2.6 - 4.4	NEMA 11, NEMA 17, NEMA 23, 60 mm
NDC 04	STEP / DIR	24 - 75 VDC	0.6 - 2.0	NEMA 17, NEMA 23, 60 mm, NEMA 34
NDC 04.V	STEP / DIR	24 - 75 VDC	0.6 - 2.0	NEMA 17, NEMA 23, 60 mm, NEMA 34
NDC 06	STEP / DIR	24 - 75 VDC	1.9 - 6.0	NEMA 17, NEMA 23, 60 mm, NEMA 34
NDC 06.V	STEP / DIR	24 - 75 VDC	1.9 - 6.0	NEMA 17, NEMA 23, 60 mm, NEMA 34
NDC 94	STEP / DIR	24 - 75 VDC	0.6 - 2.0	NEMA 17, NEMA 23, 60 mm, NEMA 34
NDC 96	STEP / DIR	24 - 75 VDC	1.9 - 6.0	NEMA 17, NEMA 23, 60 mm, NEMA 34
SAC 25	STEP / DIR	24 - 50 VAC	1.7 - 3.0	NEMA 17, NEMA 23, 60 mm, NEMA 34
SAC 26	STEP / DIR	25 - 50 VAC	3.4 - 6.0	NEMA 17, NEMA 23, 60 mm, NEMA 34
PLUS A3	STEP / DIR	39 - 85 VDC	2.4 - 8.0	NEMA 17, NEMA 23, 60 mm, NEMA 34
PLUS A4	STEP / DIR	77 - 140 VDC	1.9 - 6.0	NEMA 17, NEMA 23, 60 mm, NEMA 34
PLUS B3	STEP / DIR	28 - 62 VAC	2.4 - 8.0	NEMA 17, NEMA 23, 60 mm, NEMA 34
PLUS B4	STEP / DIR	55 - 100 VAC	1.9 - 6.0	NEMA 17, NEMA 23, 60 mm, NEMA 34
PLUS B7	STEP / DIR	28 - 62 VAC	3.0 - 10.0	NEMA 17, NEMA 23, 60 mm, NEMA 34
PLUS E3	STEP / DIR	28 - 62 VAC	2.4 - 8.0	NEMA 17, NEMA 23, 60 mm, NEMA 34
PLUS E4	STEP / DIR	55 - 100 VAC	1.9 - 6.0	NEMA 17, NEMA 23, 60 mm, NEMA 34
X-PLUS B4	STEP / DIR	110- 230 VAC (direct from the main)	2.4 - 4.0	NEMA 34 (High Voltage)
X-PLUS S4	STEP / DIR	110- 230 VAC (direct from the main)	2.4 - 4.0	NEMA 34 (High Voltage)
X-PLUS C4	STEP / DIR	110- 230 VAC (direct from the main)	2.4 - 4.0	NEMA 34 (High Voltage)
X-MIND B2	STEP / DIR	110- 230 VAC (direct from the main)	1.13 - 2.0	NEMA 34 (High Voltage)
X-MIND B4	STEP / DIR	110- 230 VAC (direct from the main)	2.3 - 4.0	NEMA 34 - NEMA 42 (High Voltage)
X-MIND B6	STEP / DIR	110- 230 VAC (direct from the main)	3.4 - 6.0	NEMA 34 - NEMA 42 (High Voltage)
HI-MOD B	STEP / DIR	32 - 75 VDC	Value set by R. T.A.	NEMA 34
GAC03	EUROCARD	42- 62 VAC	4.0 - 10.0	NEMA 23, 60 mm, NEMA 34

	DRIVE TYPE	VOLTAGE RANGE (V)	PHASE CURRENT RANGE (A)	SUGGESTED MOTORS (Flange size)
GAC04	EUROCARD	69 - 100 VAC	5.0 - 12.0	NEMA 23, 60 mm, NEMA 34
GMH 05	EUROCARD	55 - 85 VDC	1.6 - 3.0	NEMA 23, 60 mm, NEMA 34
GMH 06	EUROCARD	55 - 85 VDC	3.5 - 6.0	NEMA 23, 60 mm, NEMA 34
GMH 07	EUROCARD	55 - 85 VDC	7.0 - 12.0	NEMA 23, 60 mm, NEMA 34
GMH 09	EUROCARD	100 - 180 VDC	7.0 - 12.0	NEMA 23, 60 mm, NEMA 34
GMD 02	EUROCARD	55 - 85 VDC	1.6 - 6.0	NEMA 23, 60 mm, NEMA 34
GMD 03	EUROCARD	55 - 85 VDC	4.0 - 10.0	NEMA 23, 60 mm, NEMA 34
GMD 04	EUROCARD	95 - 140 VDC	5.0 - 12.0	NEMA 23, 60 mm, NEMA 34
GMD 06	EUROCARD	160 - 190 VDC	5.0 - 12.0	NEMA 23, 60 mm, NEMA 34
MIND A3	STEP / DIR	55 - 85 VDC	5.7 - 10.0	60 mm, NEMA 34
MIND A4	STEP / DIR	95 - 140 VDC	4.55 - 8.0	60 mm, NEMA 34
MIND A5	STEP / DIR	120 - 180 VDC	6.7 - 12.0	NEMA 34
MIND B2	STEP / DIR	55 - 85 VDC	2.3 - 4.0	NEMA 23, 60 mm, NEMA 34
MIND B3	STEP / DIR	55 - 85 VDC	5.7 - 10.0	NEMA 23, 60 mm, NEMA 34
MIND B4	STEP / DIR	95 - 140 VDC	4.5 - 8.0	NEMA 23, 60 mm, NEMA 34
MIND B5	STEP / DIR	120 - 180 VDC	6.7 - 12.0	NEMA 34
FFM01	OPTIONAL CARD	//	//	GAC, GMH, GMD Series.
FFM02	OPTIONAL CARD	//	//	GAC, GMH, GMD Series.
FFM04	OPTIONAL CARD	//	//	GAC, GMH, GMD Series.
FFM05	OPTIONAL CARD	//	//	GAC, GMH, GMD Series.
OFM30	OPTIONAL CARD	//	//	GAC, GMH, GMD Series.
OFM60	OPTIONAL CARD	//	//	GAC, GMH, GMD Series.
RMM36	OPTIONAL CARD	//	//	GAC, GMH, GMD Series.

"Not preferred models" are models which have been replaced with the latest versions. They are still available in R.T.A.'s stock, however they are not recommended for new applications.

STEPPING MOTOR DRIVES

PROGRAMMABLE



CSD J Series Drives

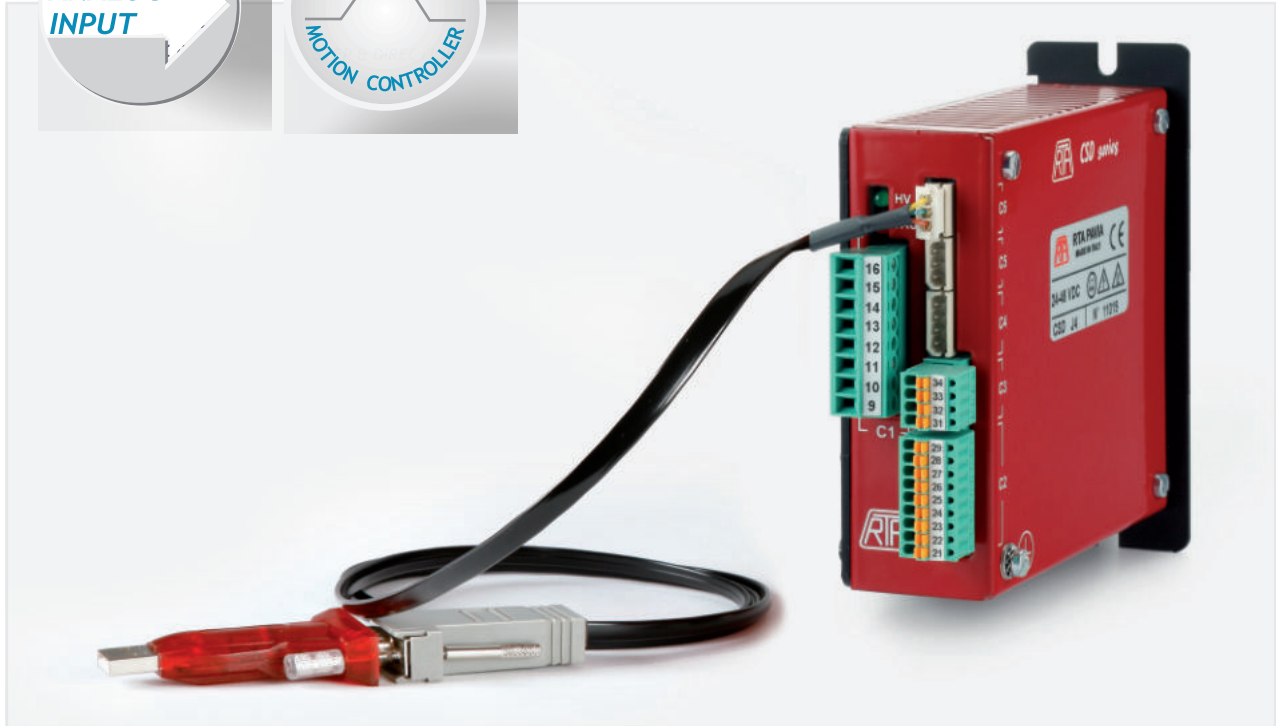

INTRODUCTION

- Series of ministep bipolar chopper drives with an on-board programmable motion controller that can be used:
 - for the interfacing, through RS485 serial line, with a central control system
 - as an independent unit.
- Presence of a dedicated analog input for the setting of motor target speed.
- Target: low-power applications needing a programmable motion controller with small size motors.

HIGHLIGHTS

- Microstepping function up to 4.000 step/rev.
- Setting of the motor target speed sampled at the beginning of the motion sequence (before motor starts running).
- Programmable motion controller allowing the connection up to 48 drives on a single serial line.
- External fans not needed: ideal both for mounting inside a metallic electrical cabinet and for stand-alone applications.

Series	Model	V _{DC} range (Volt)	I _{NP} min. (Peak value) (Amp)	I _{NP} max. (Peak value) (Amp)	Dimensions (mm)
CSD	J2	24 to 48	1.2	2.1	90x99x30
CSD	J4	24 to 48	2.6	4.4	90x99x30

TECHNICAL FEATURES

- Range of operating voltage: 24-48 V_{DC}.
- Range of current: 1.2-4.4 A. Setting up to four possible values by means of a serial line.
- Microstepping: 400, 800, 1.600, 3.200 and 500, 1.000, 2.000, 4.000 steps/revolution. Setting by means of a serial line.
- Automatic current reduction at motor standstill.
- Protections:
 - Protection against under-voltage and over-voltage.
 - Protection against a short-circuit at motor outputs.
 - Overtemperature protection with thermal sensor.
- Electronic damping facility for further acoustic noise and mechanic vibrations reduction at low and medium speed.
- Optoinsulated inputs compatible with Pull-Up or Pull-Down command signals.
- Version: boxed, equipped with crimp-type connectors. Maximum compactness.
- Warranty: 24 months.

ANALOG INPUT TO CONTROL MOTOR SPEED

- Target speed setting by means of analog input sampled at the beginning of the motion sequence (before motor starts running).
- Input setting: 0-5 V_{DC} or 0-10 V_{DC}
- Frequency range:
 - 3000 Hz- 48000 Hz (with ramp)
 - 0 Hz-4100 Hz or 0 Hz-510 Hz (without ramp)
- Possibility of matching with potentiometers of 2.2 KOhm.

PROGRAMMABLE MOTION CONTROLLER

- Communication through RS485 serial line; up to 48 drives can be connected on a single serial line. One instruction can be broadcasted to all drives.
- Various types of available instructions, as for example: indexed run with ramp, free run with ramp, indexed run without ramp, run with a programmable braking distance, zero research. Space can be programmed in relative or absolute mode (linear or circular).
- Number of steps for indexed ramp up to ± 8.338.607 in relative or absolute mode, speed from 1 to 24.000 Hz in standard resolution and from 1 to 48.000 Hz in high resolution, ramp times from 16 to 1440 msec.
- Availability of instructions to develop motion programs as, for example: conditional jump, time delay, program block and recovery, I/O management, FOR NEXT loop.
- Possibility to control the execution of 8 previously stored motion programs through hardware inputs. Accordingly, the drive can be used in stand-alone applications, without serial connection.
- 8 inputs and 3 outputs, all optically insulated. Among them 1 input and 1 output are freely programmable.
- Memory of 128 instructions kept also at drive switched-off and three run time instructions.
- A utility working in Windows® is available in order to ease motion programs development by the user.



MECHANICAL DIMENSIONS

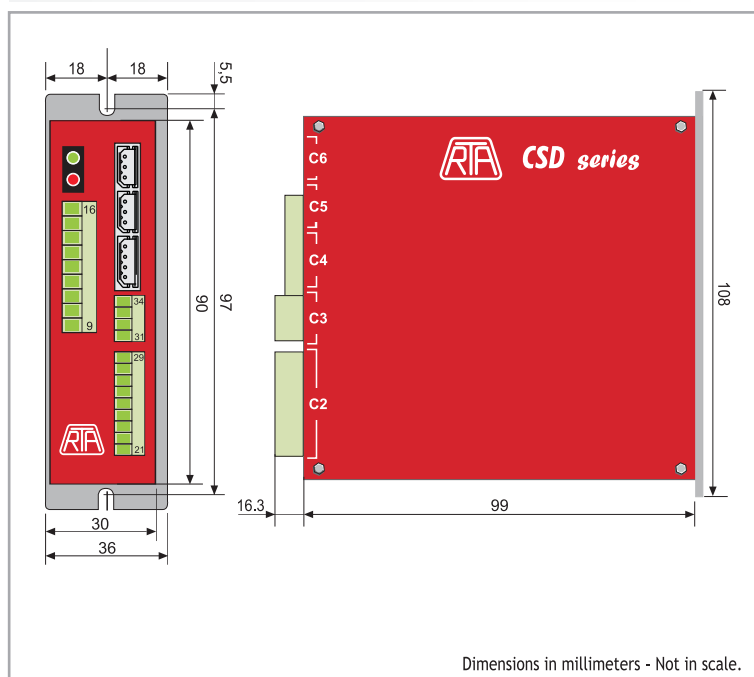

POWER AND LOGIC CONNECTIONS

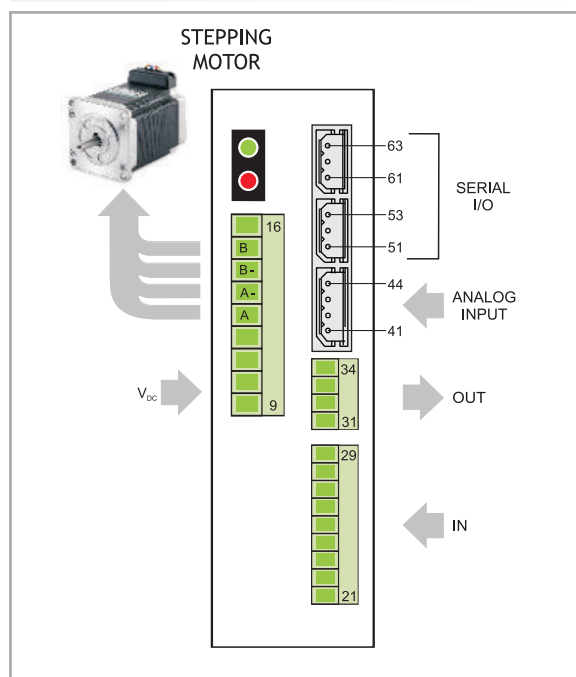

PLUS J Series Drives

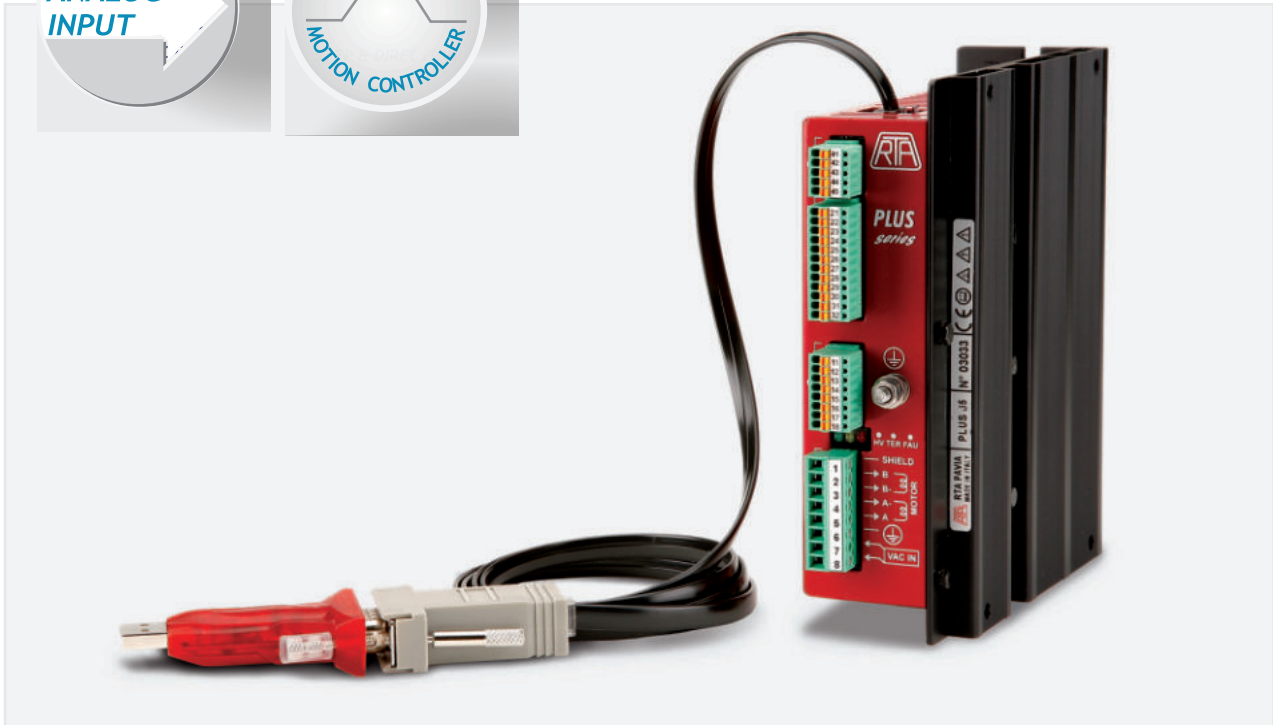
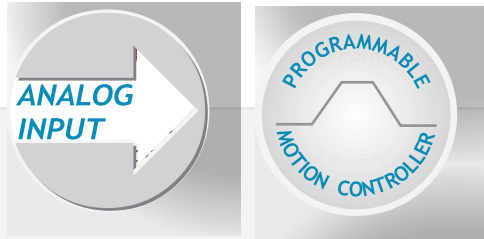

INTRODUCTION

- Series of ministepped bipolar chopper drives with an on-board programmable motion controller that can be used:
 - for the interfacing, through RS485 serial line, with a central control system
 - as an independent unit.
- Presence of a dedicated analog input for the setting of motor target speed.
- Target: medium power applications needing AC power supply and a programmable motion controller.

HIGHLIGHTS

- Microstepping function up to 4.000 step/rev.
- Setting of the motor target speed sampled at the beginning of the motion sequence (before motor starts running).
- Programmable motion controller allowing connection up to 48 drives on a single serial line.
- External fans not needed: ideal both for mounting inside a metallic electrical cabinet and for stand-alone applications.

Series	Model	V _{AC} range (Volt)	I _{NP} min. (Peak value) (Amp)	I _{NP} max. (Peak value) (Amp)	Dimensions (mm)
PLUS	J5	28 to 62	4.4	8.0	152x129x46

TECHNICAL FEATURES

- Range of operating voltage: 28-62 V_{ac}.
- Range of current: 4.4-8.0 Amp. Setting up to four possible values by means of a serial line.
- Microstepping: 400, 800, 1.600, 3.200 and 500, 1.000, 2.000, 4.000 steps/revolution. Setting by means of a serial line.
- Automatic current reduction at motor standstill.
- Protections:
 - Protection against under-voltage and over-voltage.
 - Protection against a short-circuit at motor outputs.
 - Overtemperature protection.
- Electronic damping facility for further acoustic noise and mechanic vibrations reduction at low and medium speed.
- Optoinsulated inputs compatible with Pull-Up or Pull-Down command signals.
- External fans not needed.
- Version: boxed, equipped with crimp-type connectors. Maximum compactness.

ANALOG INPUT TO CONTROL MOTOR SPEED

- Target speed setting by means of analog input sampled at the beginning of the motion sequence (before motor starts running).
- Input setting: 0-5 V_{DC} or 0-10 V_{DC}
- Frequency range:
 - 3000 Hz- 48000 Hz (with ramp)
 - 0 Hz-4100 Hz or 0 Hz-510 Hz (without ramp)
- Possibility of matching with potentiometers of 2.2 KOhm.

PROGRAMMABLE MOTION CONTROLLER

- Communication through RS485 serial line; up to 48 drives can be connected on a single serial line. One instruction can be broadcasted to all drives.
- Various types of available instructions, as for example: indexed run with ramp, free run with ramp, indexed run without ramp, run with a programmable braking distance, zero research. Space can be programmed in relative or absolute mode (linear or circular).
- Number of steps for indexed ramp up to $\pm 8.338.607$ in relative or absolute mode, speed from 1 to 24.000 Hz in standard resolution and from 1 to 48.000 Hz in high resolution, ramp times from 16 to 1440 msec.
- Availability of instructions to develop motion programs as, for example: conditional jump, time delay, program block and recovery, I/O management, FOR NEXT loop.
- Possibility to control the execution of 16 previously stored motion programs through hardware inputs. Accordingly, the drive can be used in stand-alone applications, without serial connection.
- 11 inputs and 6 outputs, all optically insulated. Among them 3 inputs and 4 outputs are freely programmable.
- Memory of 128 instructions kept also at drive switched-off and three run time instructions.
- A utility working in Windows® is available in order to ease motion programs development by the user.
- Alarm memory by use of yellow blinking led.



MECHANICAL DIMENSIONS

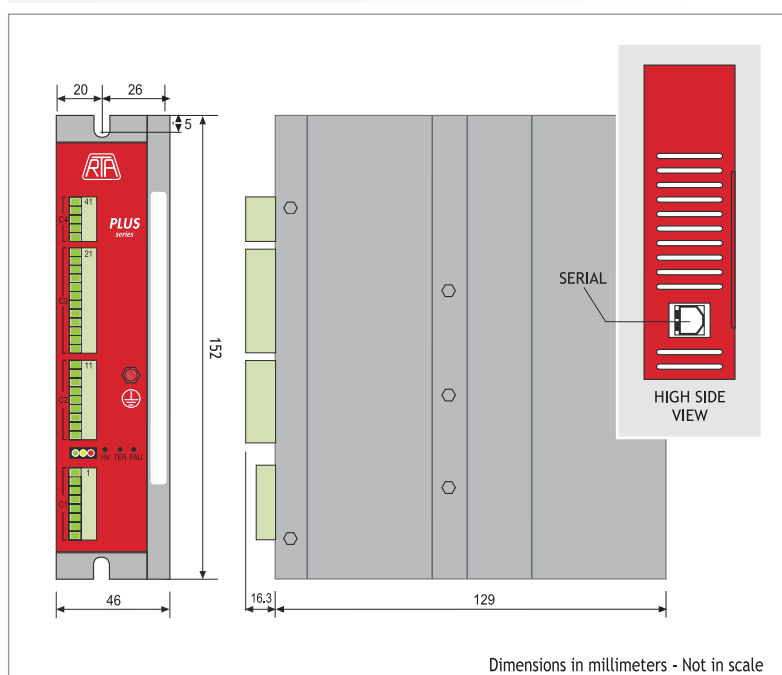

POWER AND LOGIC CONNECTIONS

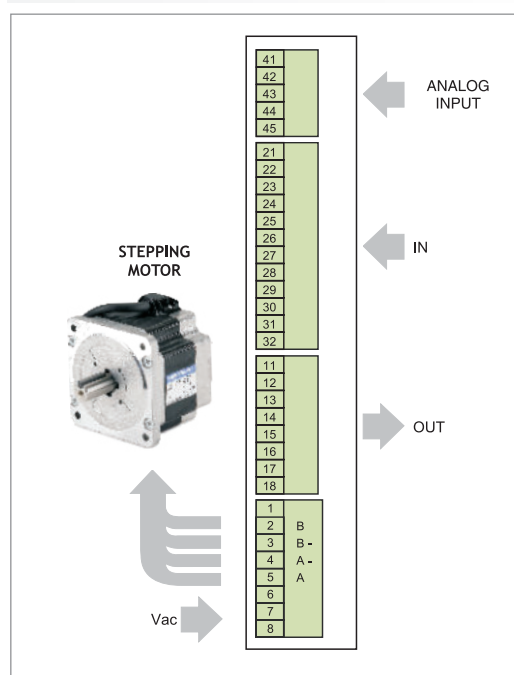

PLUS K Series Drives



INTRODUCTION

- Series of ministep bipolar chopper drives with an on-board programmable motion controller that can be used:
 - for the interfacing, through RS485 serial line, with a central control system
 - as an independent unit.
- Compact system equipped with dedicated instructions optimized for advanced motion control applications.
- Target: medium power applications needing AC power supply and a programmable motion controller.

HIGHLIGHTS

- Microstepping function up to 4.000 step/rev.
- Communication through RS485 serial line.
- Programmable motion controller allowing connection up to 48 drives on a single serial line.
- External fans not needed: ideal both for mounting inside a metallic electrical cabinet and for stand-alone applications.

Series	Model	V _{AC} range (Volt)	I _{NP} min. (Peak value) (Amp)	I _{NP} max. (Peak value) (Amp)	Dimensions (mm)
PLUS	K4	55 to 100	3.4	6.0	152x129x46
PLUS	K5	28 to 62	4.4	8.0	152x129x46

TECHNICAL FEATURES

- Range of operating voltage: 28-100 V_{ac}.
- Range of current: 3.4-8.0 Amp. Setting up to four possible values by means of a serial line.
- Microstepping: 400, 800, 1.600, 3.200 and 500, 1.000, 2.000, 4.000 steps/revolution. Setting by means of a serial line.
- Automatic current reduction at motor standstill.
- Protections:
 - Protection against under-voltage and over-voltage.
 - Protection against a short-circuit at motor outputs.
 - Overtemperature protection.
- Electronic damping facility for further acoustic noise and mechanic vibrations reduction at low and medium speed.
- Optoinsulated inputs.
- External fans not needed.
- Version: boxed, equipped with crimp-type connectors. Maximum compactness.
- Warranty: 24 months.



PROGRAMMABLE MOTION CONTROLLER

- Communication through RS485 serial line; up to 48 drives can be connected on a single serial line. One instruction can be broadcasted to all drives.
- Various types of available instructions, as for example: indexed run with ramp, free run with ramp, indexed run without ramp, run with a programmable braking distance, zero research. Space can be programmed in relative or absolute mode (linear or circular).
- Number of steps for indexed ramp up to $\pm 8.338.607$ in relative or absolute mode, speed from 1 to 24.000 Hz in standard and increased resolution, ramp times from 16 to 1440 msec.
- Availability of instructions to develop motion programs as, for example: conditional jump, time delay, program block and recovery, I/O management, FOR NEXT loop.
- Possibility to control the execution of 16 previously stored motion programs through hardware inputs. Accordingly, the drive can be used in stand-alone applications, without serial connection.
- 11 inputs and 6 outputs, all optically insulated. Among them 3 inputs and 4 outputs are freely programmable.
- Memory of 128 instructions kept also at drive switched-off and three run time instructions.
- A utility working in Windows® is available in order to ease motion programs development by the user.
- Alarm memory by use of yellow blinking led.

MECHANICAL DIMENSIONS

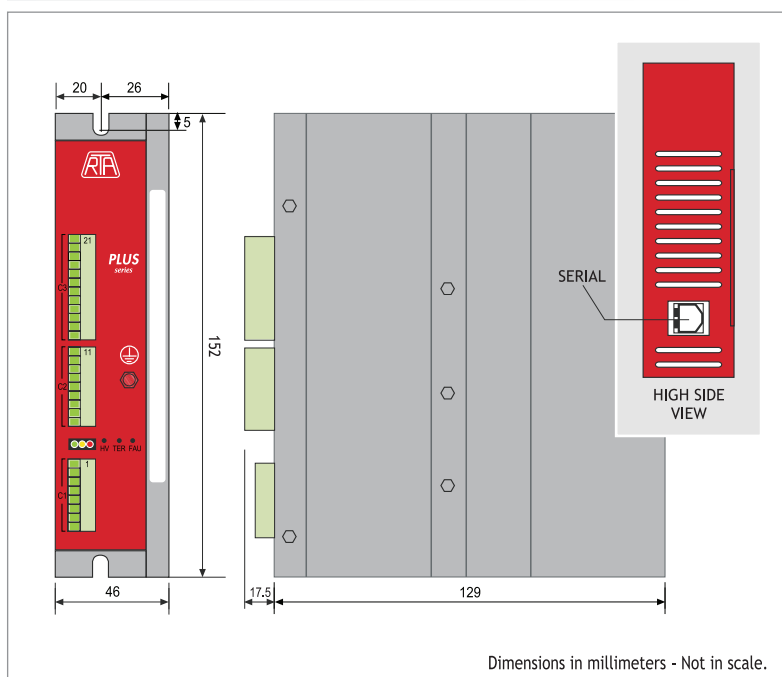

POWER AND LOGIC CONNECTIONS

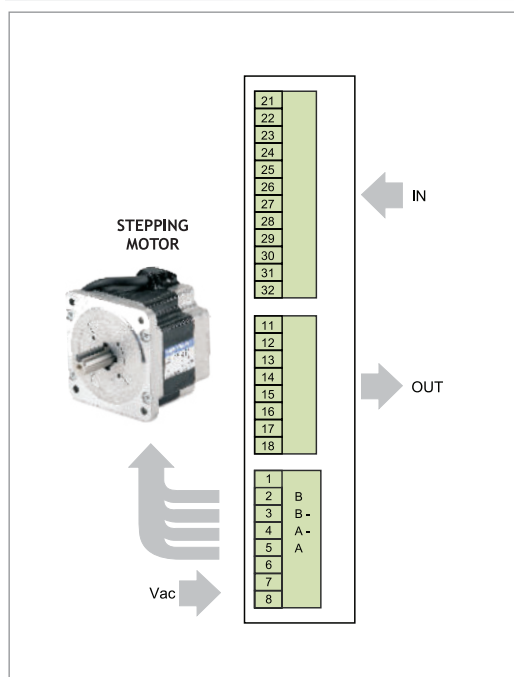

X-MIND K Series Drives



INTRODUCTION

- Series of ministep bipolar chopper drives with direct input from the main AC power supply (110-230 VAC) and an on-board programmable motion controller that can be used:
 - for the interfacing, through RS485 serial line, with a central control system
 - as an independent unit.
- Compact system equipped with dedicated instructions optimized for advanced motion control applications.
- Target: advanced applications requiring direct input from the main power supply and a programmable motion controller.

HIGHLIGHTS

- Microstepping function up to 4.000 step/rev.
- Communication through RS485 serial line.
- Programmable motion controller allowing connection up to 48 drives on a single serial line.
- External fans not needed: ideal both for mounting inside a metallic electrical cabinet and for stand-alone applications.

Series	Model	V _{AC} range (Volt)	I _{NP} min. (Peak value) (Amp)	I _{NP} max. (Peak value) (Amp)	Dimensions (mm)
X-MIND	K4	110 to 230 +/-15%	2.3	4.0	180x173x53
X-MIND	K6	110 to 230 +/-15%	3.4	6.0	180x173x53

TECHNICAL FEATURES

- Range of operating voltage: 110-230 V_{AC}.
- Range of current: 2.3-6.0 Amp. Setting up to four possible values by means of a serial line.
- Microstepping: 400, 800, 1.600, 3.200 and 500, 1.000, 2.000, 4.000 steps/revolution. Setting by means of a serial line.
- Automatic current reduction at motor standstill.
- Protections:
 - Protection against under-voltage and over-voltage.
 - Protection against a short-circuit at motor outputs.
 - Overtemperature protection.
- Electronic damping facility for further acoustic noise and mechanic vibrations reduction at low and medium speed.
- External fans not needed.
- Coupling with stepping motors rated for high voltage and equivalent or bigger than NEMA 34 is mandatory.
- Version: boxed, equipped with crimp-type connectors. Maximum compactness.
- Warranty: 24 months.



PROGRAMMABLE MOTION CONTROLLER

- Communication through RS485 serial line; up to 48 drives can be connected on a single serial line. One instruction can be broadcasted to all drives.
- Various types of available instructions, as for example: indexed run with ramp, free run with ramp, indexed run without ramp, run with a programmable braking distance, zero research. Space can be programmed in relative or absolute mode (linear or circular).
- Number of steps for indexed ramp up to $\pm 8.338.607$ in relative or absolute mode, speed from 1 to 24.000 Hz in standard and increased resolution, ramp times from 16 to 1440 msec.
- Availability of instructions to develop motion programs as, for example: conditional jump, time delay, program block and recovery, I/O management, FOR NEXT loop.
- Possibility to control the execution of 16 previously stored motion programs through hardware inputs. Accordingly, the drive can be used in stand-alone applications, without serial connection.
- 11 inputs and 6 outputs, all optically insulated. Among them 3 inputs and 4 outputs are freely programmable.
- Memory of 128 instructions kept also at drive switched-off and three run time instructions.
- A utility working in Windows® is available in order to ease motion programs development by the user.

MECHANICAL DIMENSIONS

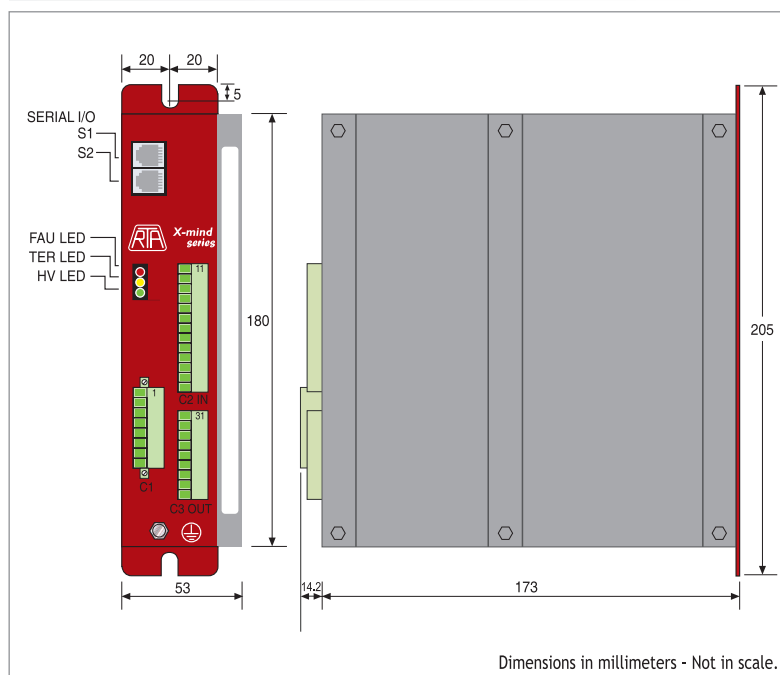

POWER AND LOGIC CONNECTIONS

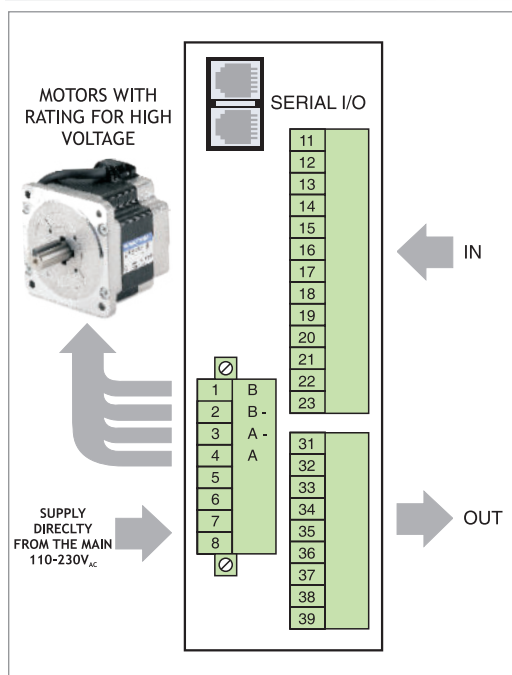



PROGRAMMABLE - NOT PREFERRED MODELS

	DRIVE TYPE	VOLTAGE RANGE (V)	PHASE CURRENT RANGE (A)	SUGGESTED MOTORS (Flange size)
MIND T2	PROGRAMMABLE	55 - 85 VDC	2.3 - 4.0	NEMA 23, 60 mm, NEMA 34
MIND T3	PROGRAMMABLE	55 - 85 VDC	5.7 - 10.0	NEMA 23, 60 mm, NEMA 34
MIND T4	PROGRAMMABLE	95 - 140 VDC	4.5 - 8.0	NEMA 34
MIND T5	PROGRAMMABLE	120 - 180 VDC	6.7 - 12.0	NEMA 34

"Not preferred models" are models which have been replaced with the latest versions. They are still available in R.T.A.'s stock, however they are not recommended for new applications.

STEPPING MOTOR DRIVES

ANALOG INPUT



ADW Series Drives

ANALOG
INPUT

ADW 06



ADW 06.V



ADW 96



INTRODUCTION

- ADW is the new R.T.A. electronic drive designed for all applications where accurate SPEED CONTROL is needed.
- The motor velocity can be regulated in 3 ways:
 - Analog voltage input
 - External potentiometer
 - Internal speed settings
- The extended ADW power range (24-75 V_{DC}, 0.65 - 6.0 A) and its versatility (four Modes of Operation) allow to access to a wide variety of application fields.

HIGHLIGHTS

- Any speed-regulated applications with variable or pre-set velocity setting.
- Conveyors:
 - Single belt transport
 - Multi belt transport with high precision position/speed synchronization.
- Jog or adjustment movements.

MODES OF OPERATION

- | | |
|--------------------------|----------------------------|
| 1 RUN MODE | 3 CW/CCW (JOG) |
| 2 START/STOP MODE | 4 LIMIT SWITCH MODE |

Series	Model	V _{DC} range (V)	I _{NP} min. (Peak value) (A)	I _{NP} max. (Peak value) (A)	Dimensions (mm)
ADW	04 - 04.V*	24 to 75	0.65	2.0	122x94x25
ADW	06 - 06.V*	24 to 75	1.9	6.0	122x94x25
ADW	94	24 to 75	0.65	2.0	129x110x34
ADW	96	24 to 75	1.9	6.0	129x110x34

* ADW 04.V and ADW 06.V versions are equipped with screw-type connectors.

TECHNICAL FEATURES

- Range of operating voltage: 24-75 V_{dc}.
- Range of current: 0.65-6 A. Easy setting of values by means of dip-switches.
- Wide speed range: 0.8 rpm to 2,000 rpm. Continuous operation zone up to approx 400 rpm, depending on motor choice.
- 64 internally selectable preset speed.
- 0-5V_{dc} or 0-10V_{dc} selectable analog command range.
- Low & High-speed motion profile.
- Adjustable internal acceleration/deceleration ramp.
- Voltage source for potentiometer available at connector.
- “Auto-stop” function.
- All opto-insulated digital inputs.
- Sync-out for multi-Axis synchronization.
- Over-voltage, short-circuit and thermal protection.
- Warranty: 24 months.



POWER AND LOGIC CONNECTIONS

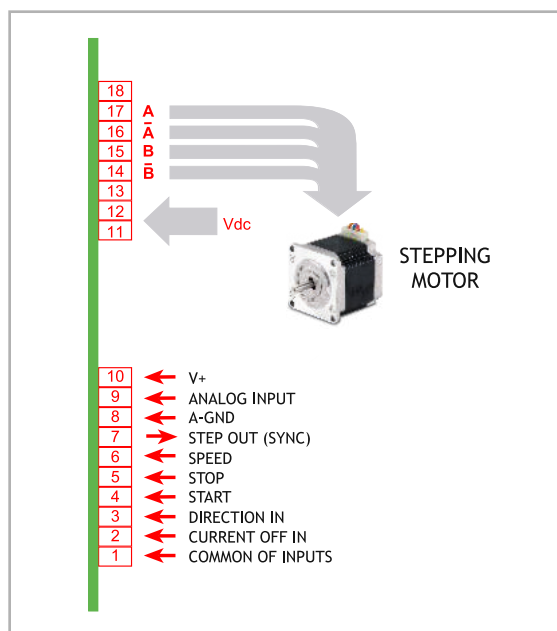

BENEFITS VS. CONVENTIONAL INVERTERS + AC MOTORS + WORM GEARBOX SETUP.

- Broader and more accurate speed range [0.8 rpm to 2,000 rpm]
- Zero-deviation motor speed control at any speed. [motor speed is not affected by variable factors like load, inertia or friction].
- The motors automatically act as brake at zero speed.
- Easy multi-axis synchronization in Position and Speed.
- No need of worm gearbox due to the high-torque at low rotation speed range [0-400 rpm].
- Smaller dimension: overall size < 1/3 compared with traditional AC Asynchronous sets.
- Lower weight.

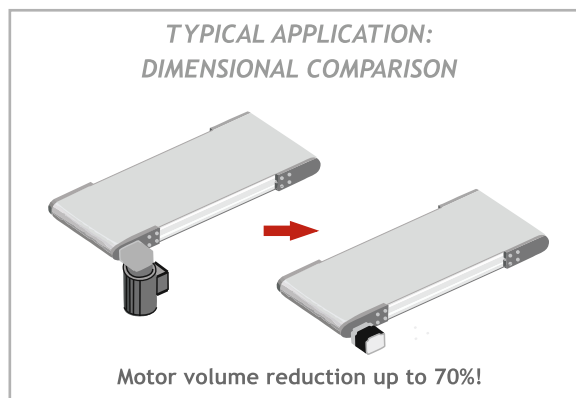

MECHANICAL DIMENSIONS

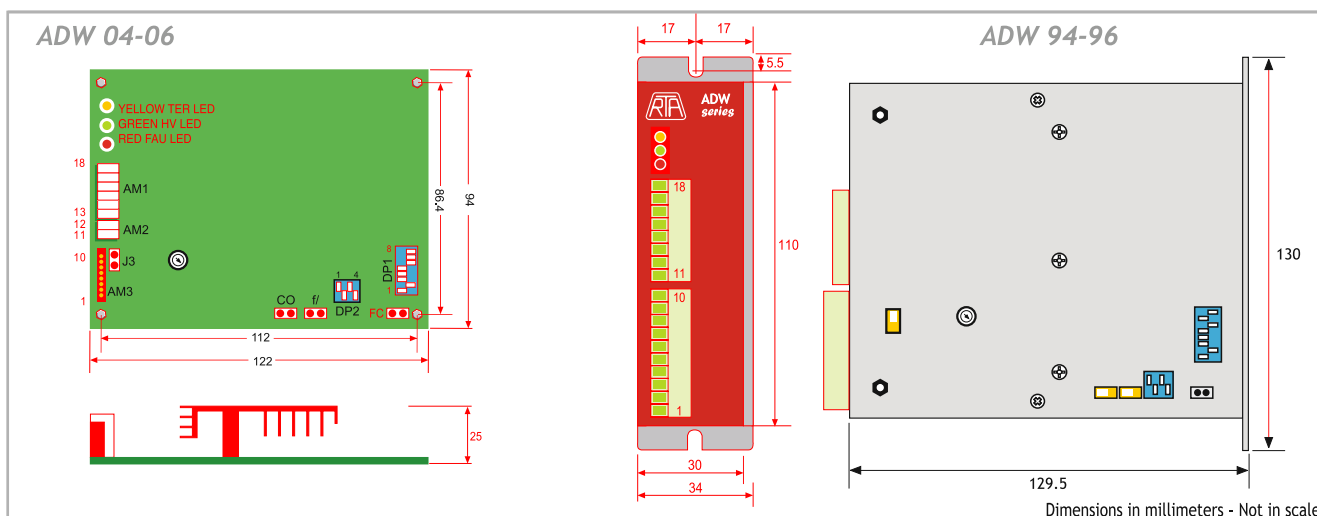

STEPPING MOTOR DRIVES

ACCESSORIES - SWITCHING POWER SUPPLIES



R-UHP 200-XX SWITCHING POWER SUPPLY

Main Features

- 16.7A output - 12 VDC
8,4A output - 24 VDC
4,2A output - 48 VDC
- AC input voltage range: 90-264 VAC
- -30~+70 °C ambient temperature
- Protections: Short Circuit, Overload, Over Voltage, Over Temperature
- V_{DC_OK} signal active
- Led indicator for power on
- Warranty: 24 months



Dimensions (Units:mm)

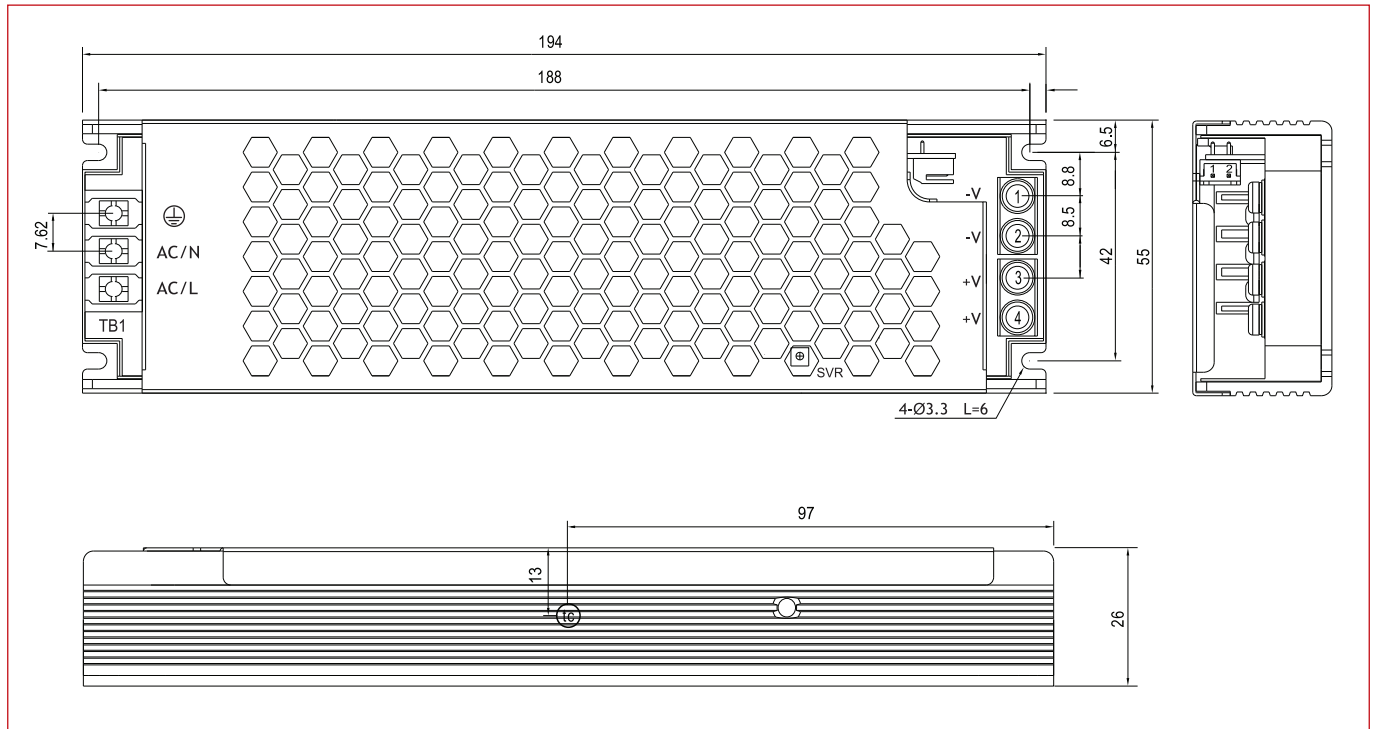

MORE INFO

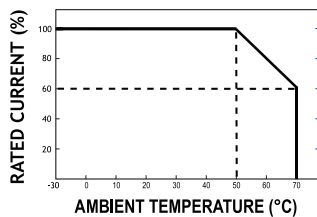

DERATING CURVE

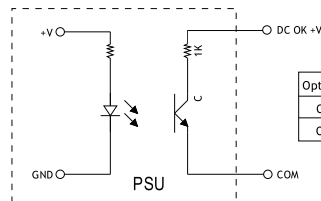

Optocoupler C-E Pin Conduction	PSU turns on	DC ok
Optocoupler C-E Pin Open	PSU turns off	DC fail
Optocoupler Rating(max.)	15Vdc/10mA resistive load	

V_{DC_OK} FUNCTION MANUAL

Specifications

MODEL	R-UHP 200-12	R-UHP 200-24	R-UHP 200-48		
OUTPUT	DC VOLTAGE	12V	24V	48V	
	RATED CURRENT	16.7A	8.4A	4.2A	
	RATED POWER (convection)	200.4W	201.6W	201.6W	
	VOLTAGE ADJ. RANGE	11.4 ~ 12.6V	22.8 ~ 25.2 V	45.6-50.4V	
	VOLTAGE TOLERANCE Note.3	±1.0%	±1.0%	±1.0%	
	LINE REGULATION	±0.3%	±0.3%	±0.3%	
	LOAD REGULATION	±0.5%	±0.5%	±0.5%	
INPUT	VOLTAGE RANGE Note.3	90 ~ 264VAC 127 ~ 370VDC	90 ~ 264VAC 127 ~ 370VDC	90 ~ 264VAC 127 ~ 370VDC	
	FREQUENCY RANGE	47 ~ 63Hz	47 ~ 63Hz	47 ~ 63Hz	
	EFFICIENCY	93%	94%	94%	
	AC CURRENT (Typ.)	2.2A/115VAC 1.1A/230VAC	2.2A/115VAC 1.1A/230VAC	2.2A/115VAC 1.1A/230VAC	
PROTECTION	OVERLOAD	110-140% rated output power		110-140% rated output power	110-140% rated output power
		Protection type : Hiccup mode, recovers automatically after fault condition is removed			
	OVER VOLTAGE	13.2 ~ 15.6 V	26.4 ~ 31.2 V	52.8 ~ 62.4V	
		Protection type :Shut down O/P voltage,re-power on to recover			
OVER TEMPERATURE	Protection type :Shut down O/P voltage, recovers automatically after temperature goes down				
FUNCTION	VDC_OK SIGNAL(Optional)	Contact rating(max.):15Vdc/10mA resistive load			
ENVIRONMENT	WORKING TEMP.	-30 ~ +70 (Refer to "Derating Curve")			
	WORKING HUMIDITY	20 ~ 90% RH non-condensing			
	VIBRATION	10 ~ 500Hz, 5G 10min./1cycle, 60min. each along X, Y, Z axes			
SAFETY STANDARDS	UL60950-1,TUV EN60950-1,EN60335-1,CCC GB4943, EAC TP TC 004 approved, Design refer to EN61558-1,-2-16				
SAFETY & EMC (Note.5)	WITHSTAND VOLTAGE	I/P-O/P:3.75KVAC I/P-FG:2KVAC O/P-FG:1.25KVAC			
	ISOLATION RESISTANCE	I/P-O/P, I/P-FG, O/P-FG:100M Ohms/500VDC/25°C/70%RH			
	EMC EMISSION	Compliance to EN55032,GB9254,Class B, EN55014,EN61000-3-2,-3,EAC TP TC 020			
	EMC IMMUNITY	Compliance to EN61000-4-2,3,4,5,6,8,11;EN61000-6-2 (EN50082-2), heavy industry level ,criterial A, EAC TP TC020			
OTHERS	MTBF	257K hrs min. MIL-HD 10217F (25 C)			
NOTE	<ol style="list-style-type: none"> 1. All parameters NOT specially mentioned are measured at 230 VAC input, rated load and 25°C ambient temperature. 2. Tolerance: includes set up tolerance, line regulation and load regulation. 3. Please check the derating curve for more details. 4. The ambient temperature derating of 5°C /1000m is needed for operating altitude greater than 2000m (6500ft). 5. The power supply is considered a component which will be installed into a final equipment. The final equipment must be re-confirmed that is still meets EMC directives. 				

Mounting

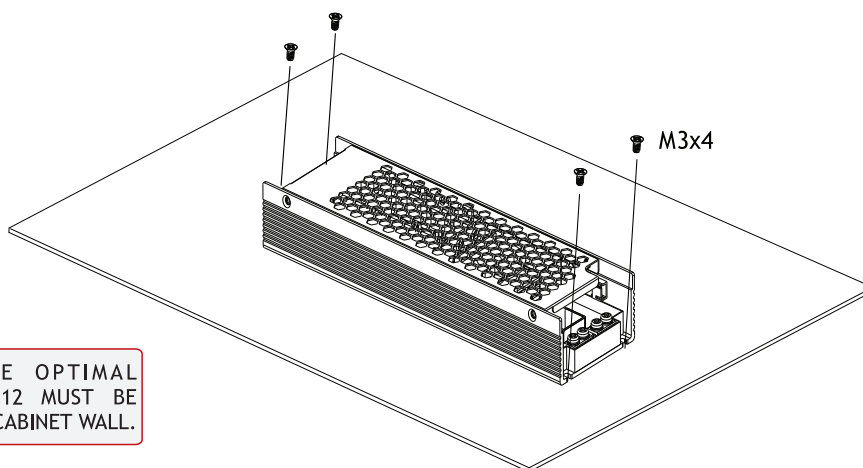

IN ORDER TO ASSURE OPTIMAL DISSIPATION, R-UHP 200-12 MUST BE INSTALLED ON ELECTRICAL CABINET WALL.

R-UHP 350-XX SWITCHING POWER SUPPLY

Main Features

- 29.2 A output - 12 VDC
- 14.6 A output - 24 VDC
- 7.3 A output - 48 VDC
- AC input voltage range: 90~264 VAC
- -30~+70 °C ambient temperature
- Protections: Short Circuit, Overload, Over Voltage, Over Temperature
- V_{DC_OK} signal active
- Led indicator for power on
- Warranty: 24 months

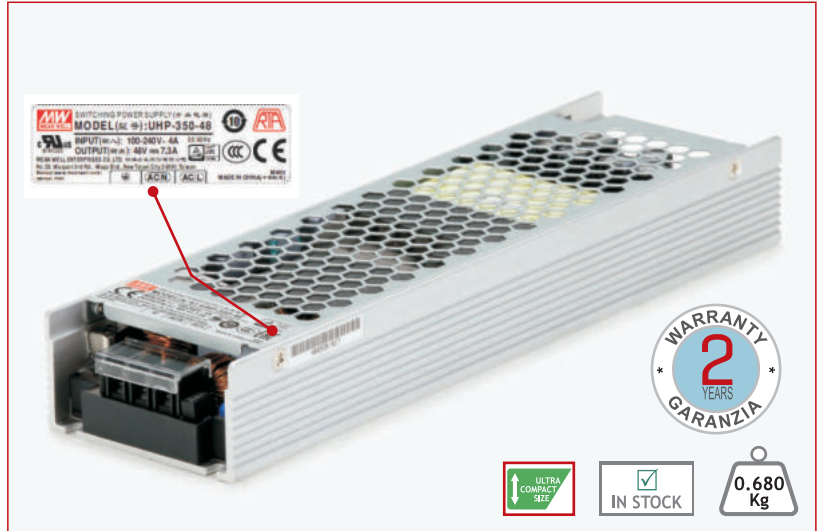

Dimensions (Units:mm)

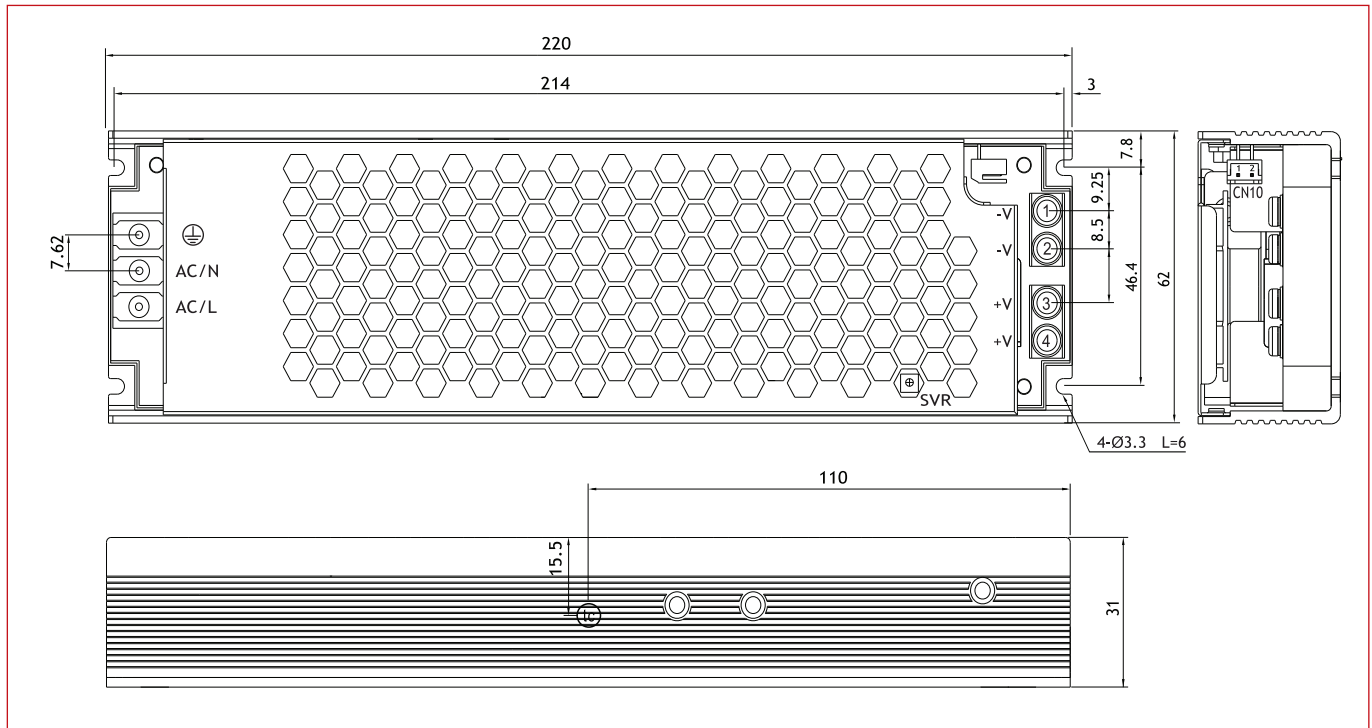

MORE INFO

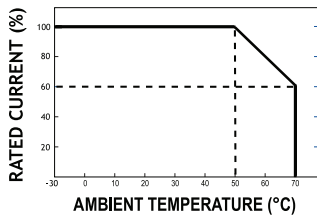

DERATING CURVE

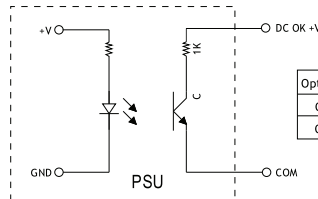

Optocoupler C-E Pin Conduction	PSU turns on	DC ok
Optocoupler C-E Pin Open	PSU turns off	DC fail
Optocoupler Rating(max.)	15Vdc/10mA resistive load	

V_{DC_OK} FUNCTION MANUAL

Specifications

MODEL		R-UHP 350-12	R-UHP 350-24	R-UHP 350-48
OUTPUT	DC VOLTAGE	12 V	24V	48V
	RATED CURRENT	29.2A	14.6A	7.3A
	RATED POWER (convection)	350.4W	350.4W	350.4W
	VOLTAGE TOLERANCE	±1.0%	±1.0%	±1.0%
	VOLTAGE ADJ. RANGE	11.4~12.6V	22.8~25.2V	45.6~ 50.4V
	LINE REGULATION	±0.3%	±0.3%	±0.3%
	LOAD REGULATION Note.2	±0.5%	±0.5%	±0.5%
INPUT	VOLTAGE RANGE Note.3	90 ~ 264VAC 127 ~ 370VDC	90 ~ 264VAC 127 ~ 370VDC	90 ~ 264VAC 127 ~ 370VDC
	FREQUENCY RANGE	47 ~ 63Hz	47 ~ 63Hz	47 ~ 63Hz
	EFFICIENCY	91%	94%	94%
	AC CURRENT (Typ.)	4A/115VAC 2A/230VAC	4A/115VAC 2A/230VAC	4A/115VAC 2A/230VAC
PROTECTION	OVERLOAD	110~140% rated output power Protection type : Hiccup mode, recovers automatically after fault condition is removed		
	OVER VOLTAGE	13.2 ~ 15.6V	26.4 ~ 31.2V	52.8 ~ 62.4V
	OVER TEMPERATURE	Protection type :Shut down O/P voltage, re-power on to recover		
FUNCTION	VDC_OK SIGNAL(Optional)	Contact rating(max.):15Vdc/10mA resistive load		
ENVIRONMENT	WORKING TEMP.	-30 ~ +70 (Refer to "Derating Curve")		
	WORKING HUMIDITY	20 ~ 90% RH non-condensing		
	VIBRATION	10 ~ 500Hz, 5G 10min./1cycle, 60min. each along X, Y, Z axes		
	SAFETY STANDARDS	UL60950-1,TUV EN60950-1,EN60335-1,CCC GB4943, EAC TP TC 004 approved, Design refer to EN61558-1,-2-16		
SAFETY & EMC (Note.5)	WITHSTAND VOLTAGE	I/P-O/P:3.75KVAC I/P-FG:2KVAC O/P-FG:1.25KVAC		
	ISOLATION RESISTANCE	I/P-O/P, I/P-FG, O/P-FG:100M Ohms/500VDC/25°C/70%RH		
	EMC EMISSION	Compliance to EN55032,GB9254,Class B, EN55014,EN61000-3-2,-3,EAC TP TC 020		
	EMC IMMUNITY	Compliance to EN61000-4-2,3,4,5,6,8,11;EN61000-6-2 (EN50082-2), heavy industry level ,criterial A, EAC TP TC 020		
OTHERS	MTBF	285 K hrs min. MIL-HDBK-217F (25°C)		
NOTE	<p>1. All parameters NOT specially mentioned are measured at 230 VAC input, rated load and 25°C ambient temperature.</p> <p>2. Tolerance: includes set up tolerance, line regulation and load regulation.</p> <p>3. Please check the derating curve for more details.</p> <p>4. The ambient temperature derating of 3.5°C /1000m with fanless models and of 5°C/1000m with fan models for operating altitude higher than 2000m (6500ft).</p> <p>5. The power supply is considered a component which will be installed into a final equipment. The final equipment must be re-confirmed that it still meets EMC directives.</p>			

Mounting

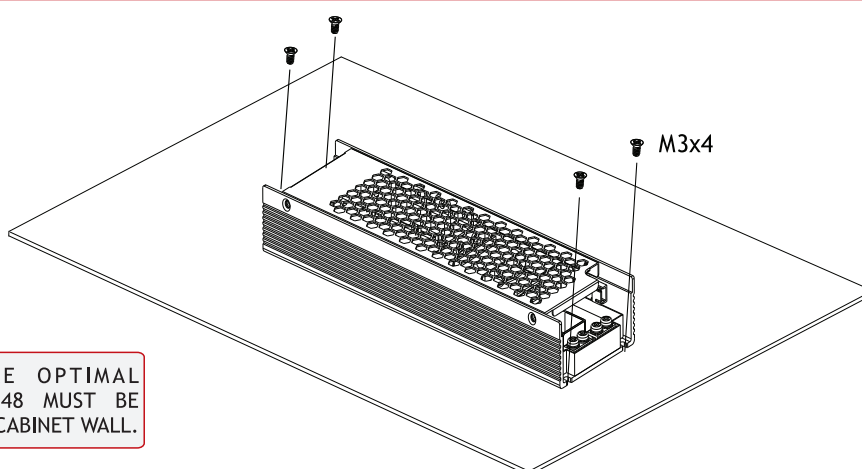

R-UHP 500-XX SWITCHING POWER SUPPLY

Main Features

- 41.7 A output - 12 VDC
20.9 A output - 24 VDC
10.45 A output - 48 VDC
- AC input voltage range: 90~264 VAC
- -30~+70 °C ambient temperature
- Protections: Short Circuit, Overload, Over Voltage, Over Temperature
- V_{DC_OK} signal active
- Led indicator for power on
- Warranty: 24 months

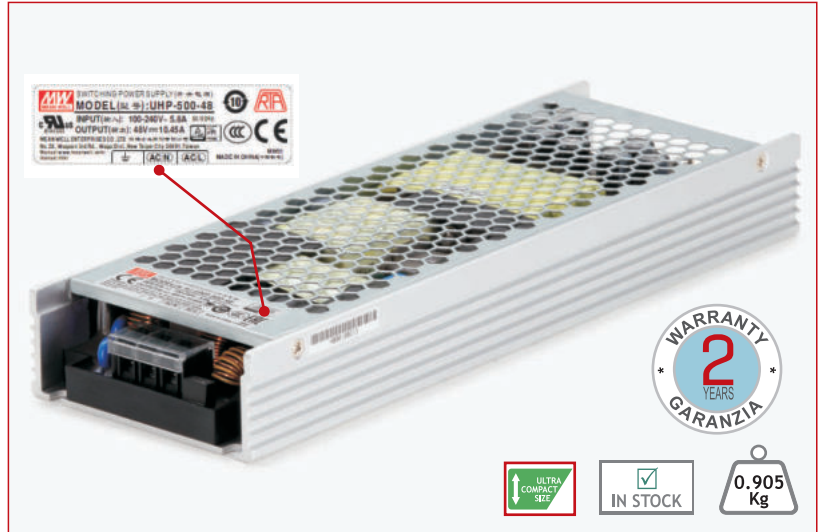

Dimensions (Units:mm)

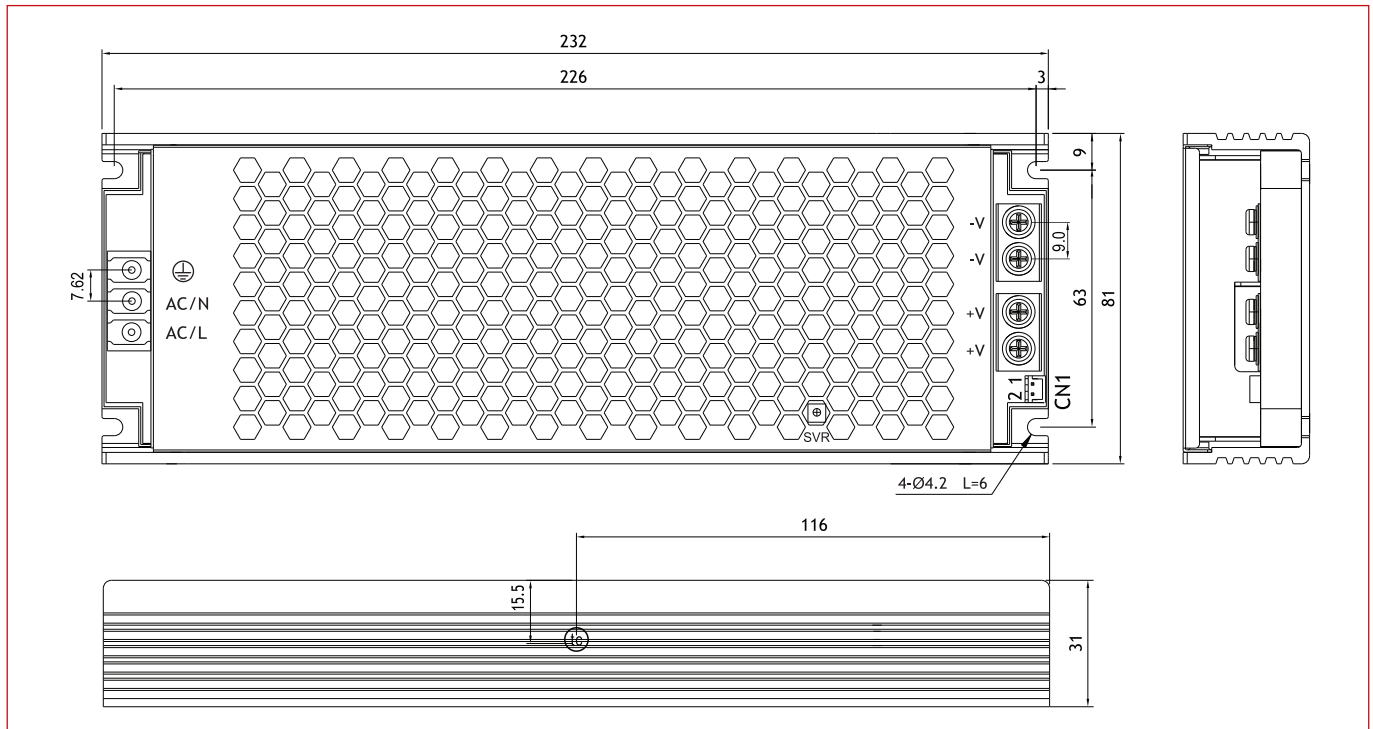

MORE INFO

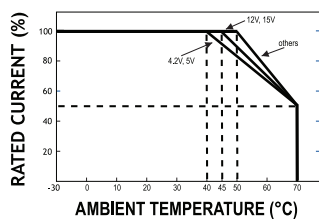

DERATING CURVE

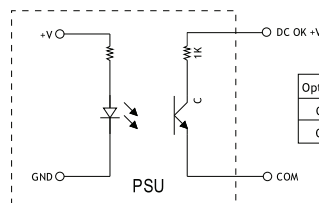

Optocoupler C-E Pin Conduction	PSU turns on	DC ok
Optocoupler C-E Pin Open	PSU turns off	DC fail
Optocoupler Rating(max.)	15Vdc/10mA resistive load	

V_{DC_OK} FUNCTION MANUAL

Specifications

MODEL	R-UHP 500-12		R-UHP 500-24		R-UHP 500-48	
OUTPUT	DC VOLTAGE	12V	24V	48V		
	RATED CURRENT	41.7A	20.9A	10.45A		
	RATED POWER (convection)	500.4W	501.6W	501.6W		
	VOLTAGE ADJ. RANGE	11.4 ~ 12.6	22.8 ~ 25.2V	45.6-50.4V		
	VOLTAGE TOLERANCE Note.3	±1.0%	±1.0%	±1.0%		
	LINE REGULATION	±0.3%	±0.3%	±0.3%		
	LOAD REGULATION	±0.5%	±0.5%	±0.5%		
INPUT	VOLTAGE RANGE Note.3	90 ~ 264VAC 127 ~ 370VDC	90 ~ 264VAC 127 ~ 370VDC	90 ~ 264VAC 127 ~ 370VDC		
	FREQUENCY RANGE	47 ~ 63Hz	47 ~ 63Hz	47 ~ 63Hz		
	EFFICIENCY	94%	94.5%	95%		
	AC CURRENT (Typ.)	4.85A/115VAC 2.6A/230VAC	4.85A/115VAC 2.6A/230VAC	4.85A/115VAC 2.6A/230VAC		
PROTECTION	OVERLOAD	110-140% rated output power		110-140% rated output power		110-140% rated output power
		Protection type : Hiccup mode, recovers automatically after fault condition is removed				
	OVER VOLTAGE	13.2 ~ 15.6	26.4 ~ 31.2V	52.8 ~ 62.4V		
		Protection type : Shut down O/P voltage, re-power on to recover				
	OVER TEMPERATURE	Protection type : Shut down O/P voltage, recovers automatically after temperature goes down				
FUNCTION	VDC_OK SIGNAL(Optional)	Contact rating(max.):30Vdc/1A resistive load				
ENVIRONMENT	WORKING TEMP.	-20 ~ +70 °C (Refer to "Derating Curve")				
	WORKING HUMIDITY	20 ~ 90% RH non-condensing				
	VIBRATION	10 ~ 500Hz, 5G 10min./1cycle, 60min. each along X, Y, Z axes				
SAFETY & EMC (Note.5)	SAFETY STANDARDS	UL60950-1, TUV EN60950-1, EN60335-1, CCC GB4943, EAC TP TC 004 approved, Design refer to EN61558-1,-2-16				
	WITHSTAND VOLTAGE	I/P-O/P:3 75KVAC I/P-FG:2KVAC O/P-FG:1 25KVAC				
	ISOLATION RESISTANCE	I/P-O/P, I/P-FG, O/P-FG:100M Ohms/500VDC/25 °C/70%RH				
	EMC EMISSION	Compliance to EN55032, GB9254, Class B, EN55014, EN61000-3-2, -3, EAC TP TC 020				
	EMC IMMUNITY	Compliance to EN61000-4-2,3,4,5,6,8,11; EN61000-6-2 (EN50082-2), heavy industry level ,criterial A, EAC TP TC020				
OTHERS	MTBF	168K hrs min.		MIL-HDBK-217F (25 °C)		
NOTE	<ol style="list-style-type: none"> 1. All parameters NOT specially mentioned are measured at 230 VAC input, rated load and 25 °C ambient temperature. 2. Tolerance: includes set up tolerance, line regulation and load regulation. 3. Please check the derating curve for more details. 4. The ambient temperature derating of 5 °C /1000m is needed for operating altitude greater than 2000m (6500ft). 5. The power supply is considered a component which will be installed into a final equipment. The final equipment must be re-confirmed that is still meets EMC directives. 					

Mounting

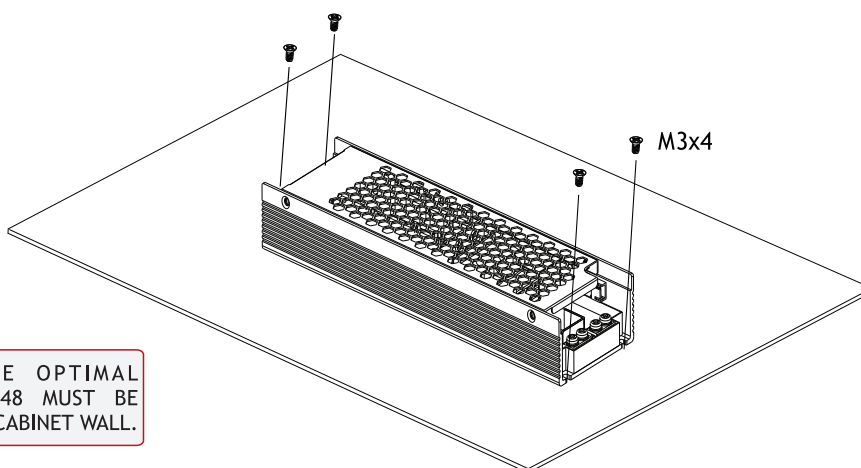

IN ORDER TO ASSURE OPTIMAL DISSIPATION, R-UHP 500-48 MUST BE INSTALLED ON ELECTRICAL CABINET WALL.

R-NDR-240-XX SWITCHING POWER SUPPLY

Main Features

- 10 A output - 24 VDC
- 5 A output - 48 VDC
- AC input voltage range: 90~264 VAC
- -20~+70 °C ambient temperature
- Protections: Short Circuit, Overload, Over Voltage, Over Temperature
- DC output voltage adjustable
- DIN rail TS-35 / 7.5 or 15 mounting
- Warranty: 24 months



Dimensions (Units:mm)

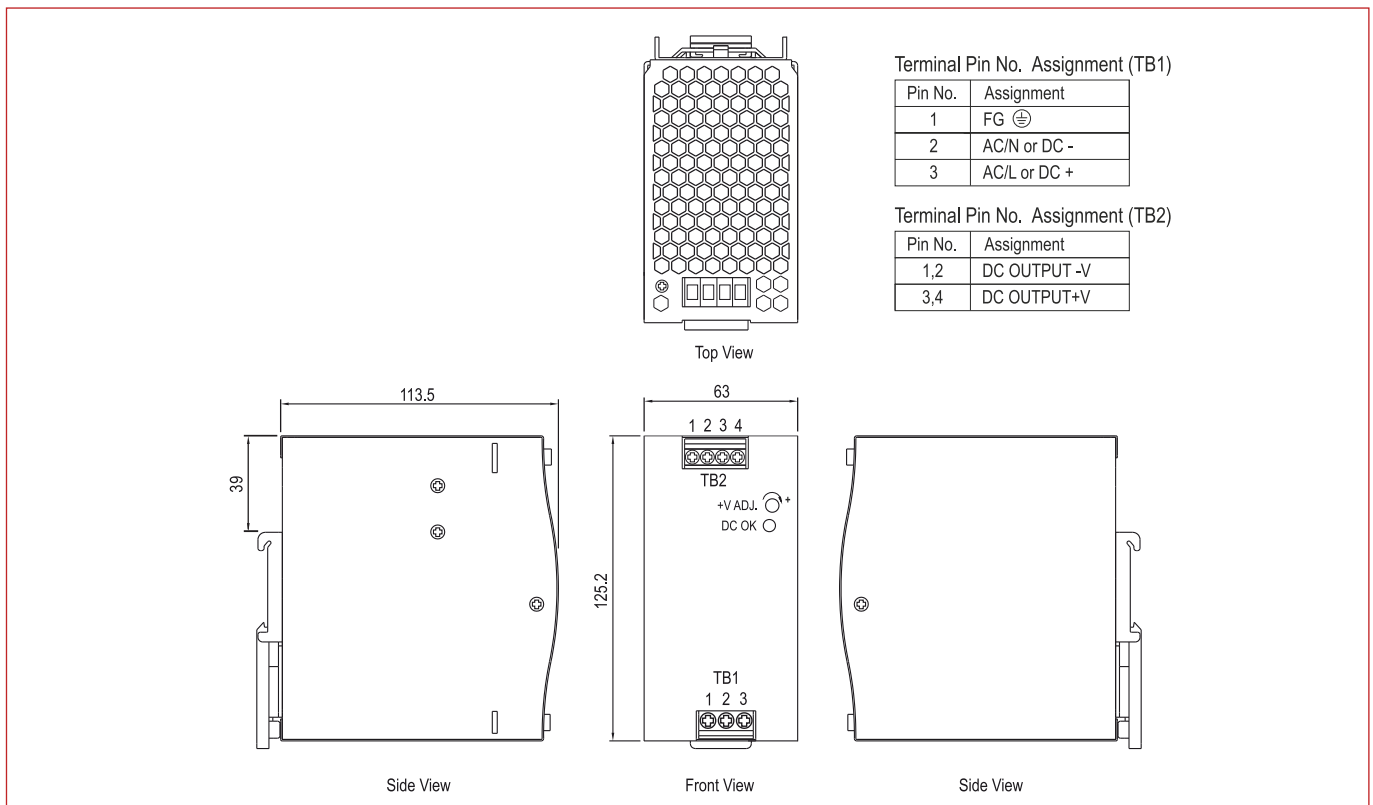

MORE INFO

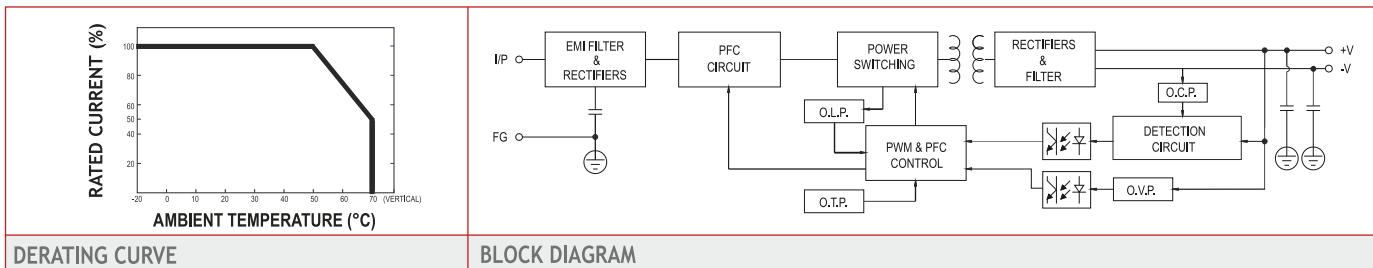

Specifications

MODEL	R-NDR-240-24		R-NDR-240-48		
OUTPUT	DC VOLTAGE	24 V		48V	
	RATED CURRENT	10A		5A	
	RATED POWER (convection)	240W		240W	
	VOLTAGE ADJ. RANGE	24~28V		48-55V	
	VOLTAGE TOLERANCE Note.3	±1.0%		±1.0%	
	LINE REGULATION	±0.5%		±0.5%	
	LOAD REGULATION	±1.0%		±1.0%	
INPUT	VOLTAGE RANGE Note.3	90 ~ 264VAC	127 ~ 370VDC	90 ~ 264VAC	127 ~ 370VDC
	FREQUENCY RANGE	47 ~ 63Hz		47 ~ 63Hz	
	EFFICIENCY	88.5%		88,5%	
	AC CURRENT (Typ.)	2.5A/115VAC	1.3A/230VAC	2.5A/115VAC	1.3A/230VAC
PROTECTION	OVERLOAD	105-130% rated output power		105-130% rated output power	
		Protection type : Constant current limiting, recovers automatically after fault condition is removed			
	OVER VOLTAGE	29~33V		56-65V	
	Protection type :Shut down O/P voltage,re-power on to recover				
	OVER TEMPERATURE Protection type :Shut down O/P voltage, recovers automatically after temperature goes down				
ENVIRONMENT	WORKING TEMP.	-20 ~ +70 (Refer to "Derating Curve")			
	WORKING HUMIDITY	20 ~ 95% RH non-condensing			
	VIBRATION	10 ~ 500Hz 2G 10min./1c cle 60min. each alon X Y Z axes			
SAFETY & EMC (Note.5)	SAFETY STANDARDS	UL508, TUV EN60950-1 approved			
	WITHSTAND VOLTAGE	I/P-O/P:3KVAC I/P-FG:2KVAC O/P-FG:0.5KVAC			
	ISOLATION RESISTANCE	I/P-O/P, I/P-FG, O/P-FG:>100M Ohms / 500VDC / 25°C / 70% RH			
	EMC EMISSION	Compliance to EN55032 (CISPR32), EN61204-3 Class B, EN61000-3-2,-3			
	EMC IMMUNITY	Compliance to EN61000-4-2,3,4,5,6,8,11, EN55024, EN61000-6-2 (EN50082-2), EN61204-3, heavy industry level, criteria A			
OTHERS	MTBF	230.2K hrs min.		MIL-HDBK-217F (25°C)	
NOTE	<ol style="list-style-type: none"> 1. All parameters NOT specially mentioned are measured at 230 VAC input, rated load and 25°C ambient temperature. 2. Tolerance: includes set up tolerance, line regulation and load regulation. 3. Please check the derating curve for more details. 4. The ambient temperature derating of 5°C /1000m is needed for operating altitude greater than 2000m (6500ft). 5. The power supply is considered a component which will be installed into a final equipment. The final equipment must be re-confirmed that is still meets EMC directives. 				

Mounting

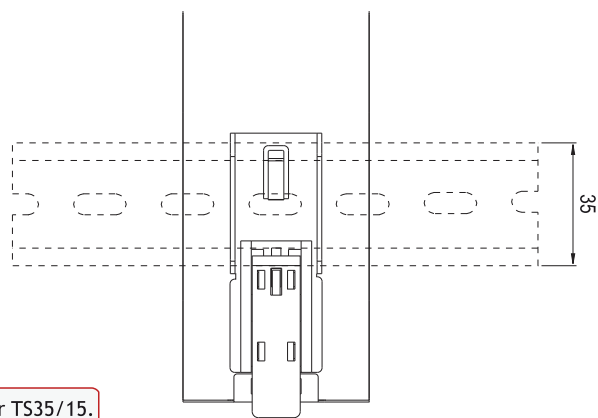

This series fits DIN rail TS35/7.5 or TS35/15.

Back View

R-NDR-480-XX SWITCHING POWER SUPPLY

Main Features

- 20 A output - 24 VDC
- 10 A output - 48 VDC
- AC input voltage range: 90~264 VAC
- -20~+70 °C ambient temperature
- Protections: Short Circuit, Overload, Over Voltage, Over Temperature
- DC output voltage adjustable
- DIN rail TS-35 / 7.5 or 15 mounting
- Warranty: 24 months



Dimensions (Units:mm)

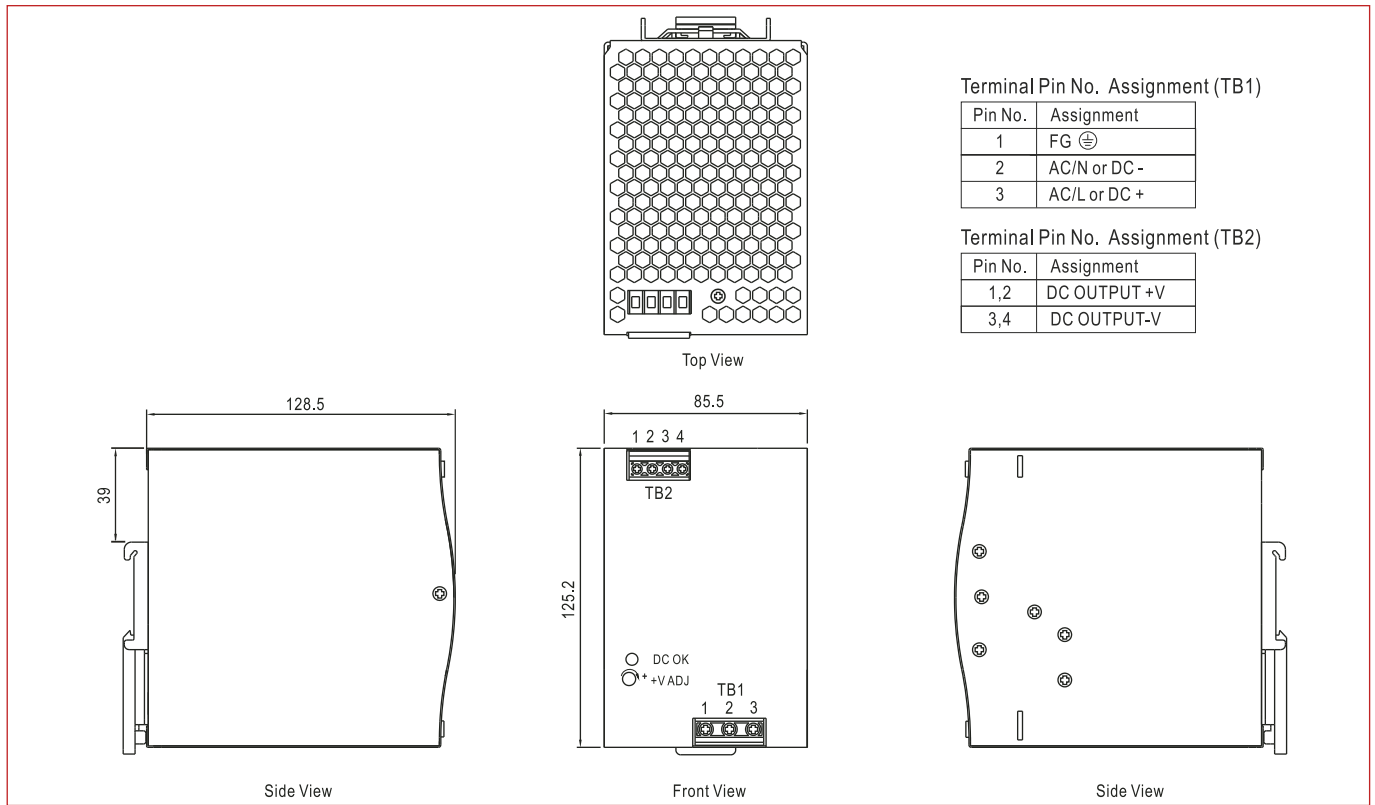

MORE INFO

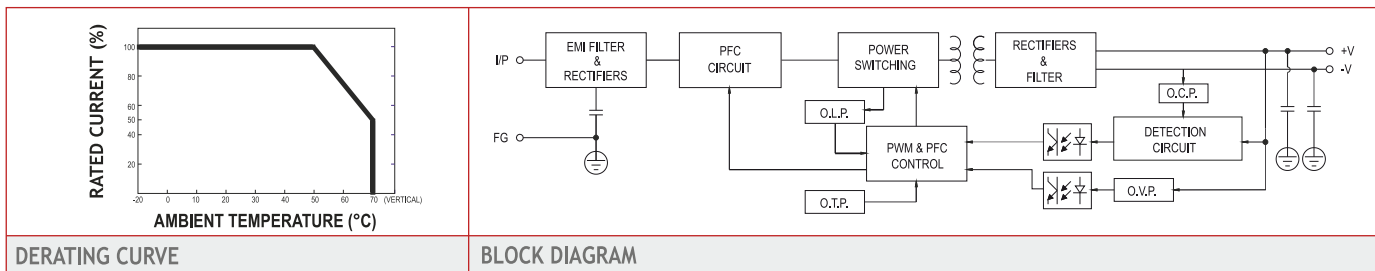

Specifications

MODEL	R-NDR-480-24	R-NDR-480-48	
OUTPUT	DC VOLTAGE	24 V	48 V
	RATED CURRENT	20A	10A
	RATED POWER (convection)	480W	480W
	VOLTAGE ADJ. RANGE	24-28V	48-55V
	VOLTAGE TOLERANCE Note.3	±1.0%	±1.0%
	LINE REGULATION	±0.5%	±0.5%
	LOAD REGULATION	±1.0%	±1.0%
INPUT	VOLTAGE RANGE Note.3	90 ~ 264VAC 127 ~ 370VDC	90 ~ 264VAC 127 ~ 370VDC
	FREQUENCY RANGE	47 ~ 63Hz	47 ~ 63Hz
	EFFICIENCY	92.5%	92.5%
	AC CURRENT (Typ.)	4.8A/115 VAC 2.4A/230VAC	4.8A/115 VAC 2.4A/230VAC
PROTECTION	OVERLOAD	105-130% rated output power Protection type : Constant current limiting, until will shut down after 3 seconds, re-power to recover	
	OVER VOLTAGE	29-33V	56-65V
		Protection type :Shut down O/P voltage,re-power on to recover	
	OVER TEMPERATURE	Protection type :Shut down O/P voltage, recovers automatically after temperature goes down	
ENVIRONMENT	WORKING TEMP.	-20 ~ +70 (Refer to "Derating Curve")	
	WORKING HUMIDITY	20 ~ 95% RH non-condensing	
	VIBRATION	10 ~ 500Hz 2G 10min./1c cle 60min. each along X Y Z axes	
SAFETY & EMC (Note.5)	SAFETY STANDARDS	UL508, TUV EN60950-1 approved	
	WITHSTAND VOLTAGE	I/P-O/P:3KVAC I/P-FG:2KVAC O/P-FG:0.5KVAC	
	ISOLATION RESISTANCE	I/P-O/P, I/P-FG, O/P-FG:>100M Ohms / 500VDC / 25°C / 70% RH	
	EMC EMISSION	Compliance to EN55032 (CISPR32), EN61204-3 Class B, EN61000-3-2,-3	
	EMC IMMUNITY	Compliance to EN61000-4-2,3,4,5,6,8,11, EN55024, EN61000-6-2 (EN50082-2), EN61204-3, heavy industry level, criteria A	
OTHERS	MTBF	146.8K hrs min. MIL-HDBK-217F (25°C)	
NOTE	<p>1. All parameters NOT specially mentioned are measured at 230 VAC input, rated load and 25°C ambient temperature.</p> <p>2. Tolerance: includes set up tolerance, line regulation and load regulation.</p> <p>3. Please check the derating curve for more details.</p> <p>4. The ambient temperature derating of 5°C / 1000m is needed for operating altitude greater than 2000m (6500ft).</p> <p>5. The power supply is considered a component which will be installed into a final equipment. The final equipment must be re-confirmed that it still meets EMC directives.</p>		

Mounting

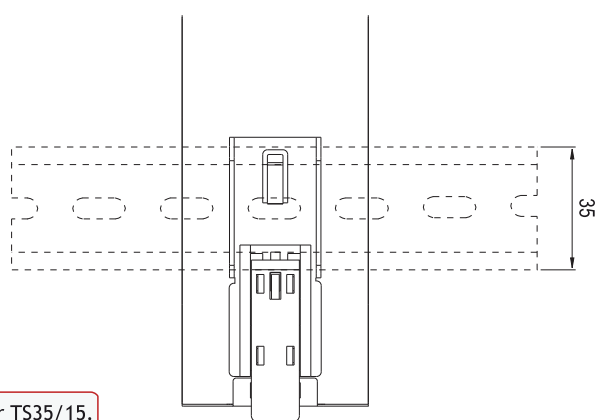

This series fits DIN rail TS35/7.5 or TS35/15.

Back View

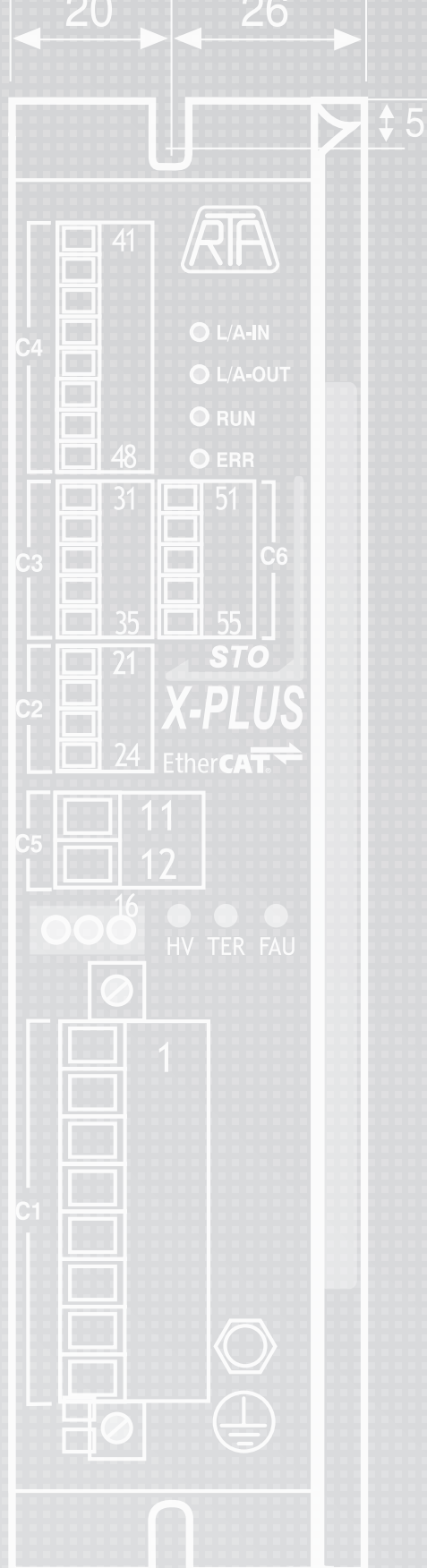

ITALY

Corporate Headquarters

R.T.A.srl
 Via E. Mattei 15, Fraz. Divisa - 27020 Marcignago (PV) ITALY
 T +39.0382.929.855 | F +39.0382.929.150 | info@rta.it
 www.rta.it

Local Branches

R.T.A. Filiale Centro
 Centro Direzionale Cavour
 Via Cavour 2, 40055 Villanova di Castenaso (BO) ITALY
 T +39.051.780141 | rtabo@rta.it

R.T.A. Filiale Nord-Est
 Via D. Alighieri 4, 30034 Mira (VE) ITALY
 T +39.041.5600332 | F +39.041.5600165 | rtane@rta.it

GERMANY

R.T.A. Deutschland GmbH
 Bublitzer Strasse 34, 40599 Düsseldorf GERMANY
 T +49.211.749.668.60 | F +49.211.749.668.66 | info@rta-deutschland.de
 www.rta-deutschland.de

SPAIN

R.T.A. Ibérica
 C/Generalitat 22, Local 1 - 08850 Gava - Barcelona SPAIN
 T +34 936.388.805 | F +34 936.334.595 | info@rta-iberica.es
 www.rta-iberica.es

INDIA

R.T.A. India Pvt
 Teerth Business Center
 3rd Floor, Unit No. 7, Block EL - 15, MIDC Bhosari
 Pimpri-Chinchwad, Pune 411026 INDIA
 T +91 942.250.744.5 | rtain@rta-india.in
 www.rta-india.in



CATALOGUE
DIGITAL EDITION



Look Ahead!