

Printed Board Connectors – general information

Page

Creepage and clearance distances	00.04
Specifications, assembly instructions	00.06
System description	00.08
Male and female connectors with pcb fixings	00.12
Terminations	00.14

General
information

Extract DIN VDE 0110-04.97*)

This standard is a technical adaptation of IEC Report 664/664A and specifies, in general, the minimum insulation distances for equipment. It can be used by committees to protect persons and property in the best possible way from the effects of electrical voltages or currents (e.g. fire hazard) or from functional failure of the equipment by providing adequate dimensioning of clearances and creepage distances in equipment.

Rated impulse without voltage

In allocation of the equipment to an installation category, the following factors shall be taken into account:

- Overvoltages which can enter the equipment from outside across the terminals.
- Overvoltages generated in the equipment itself and occurring at the terminals.

The following parameters apply to:

Installation category I

Equipment is intended for use only in appliances or installation parts, in which no overvoltages can occur.

Equipment in this installation category is normally operated at extra low voltage.

Installation category II

Equipment is intended for use in installations or parts of installations, in which lightning overvoltages need not be considered. Overvoltages caused by switching must be taken into account.

This includes for example domestic appliances.

Installation category III

Equipment is intended for use in installations or parts of installations, in which lightning overvoltages need not be considered, but which are subject to particular requirements with regard to the safety and availability of the equipment and its supply systems.

This includes equipment for fixed installation such as protective devices, relays, switches and sockets.

Installation category IV

Equipment is intended for use in installations or parts of installations, in which lightning overvoltages must be taken into account.

This includes equipment for connection to overhead lines such as omnidirectional control receivers and meters.

For circuits or parts of circuits inside the equipment, clearances may be dimensioned directly for the expected overvoltages. If the expected overvoltages are not impulse voltages but DC or AC voltages, the maximum value of these voltages shall be determined as the rated impulse withstand voltage for clearances both for homogeneous and inhomogeneous field.

Degree of pollution

Pollution degree 1: No pollution or only dry, non-conductive pollution occurs. The pollution has no influence.

Pollution degree 2: Only non-conductive pollution occurs. A temporary conductive caused by condensation must be expected occasionally.

The degrees of pollution 3 and 4 are in this case not considered, as they are not relevant for the connectors shown in this catalogue. The minimum creepages in table 00.04 refer to the CTI-value for insulation group III a/b.

Clearance

The clearance is defined as shortest distance through the air between two conductive elements.

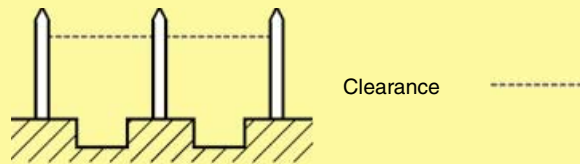

To identify the clearance distance

- Define the installation category
- Define the degree of pollution expected
- Select the rated impulse withstand voltage from table 00.01
- Select the minimum required clearance from table 00.02

Exemplary calculation

What voltage can be used, if the clearance, the installation category and the degree of pollution are known:

Clearance	Installation category	Degree of pollution	Voltage phase-to-earth
1.2 mm	II	2	150 V
3.0 mm	II	2	600 V
4.5 mm	II	2	600 V

Creepage

The creepage is defined as shortest distance on the surface of an insulating material between two conductive elements.

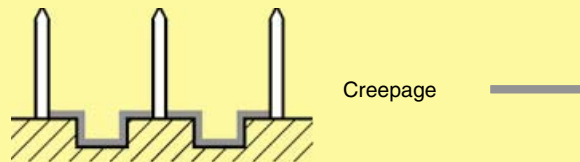

To identify the creepage distance

- Define the installation category
- Define the degree of pollution expected
- From the nominal voltage and the type of supply system select the rated voltage from table 00.03 a/b
- From the rated voltage and degree of pollution select the minimum creepage required in table 00.04

For the dimensioning of the creepage distance the tracking formation of the insulating material has to be considered. If not indicated contrary, the CTI value of the insulating material is <400 and the isolation group is III a/b.

Exemplary calculation

What voltage can be used, if the creepage, the installation category and the degree of pollution are known:

Creepage	Installation category	Degree of pollution	Nominal voltage of supply system
1.2 mm	II	2	50 V
3.0 mm	II	2	220 V
8.0 mm	II	2	600 V

*) It is the users responsibility to ensure that the complete current issue of the specification is considered.

Table 00.01

Voltages phase-to-earth derived from rated system voltages up to $U_{r.m.s.}$ and U_-	Rated impulse withstand voltages in kV for installation category (Voltage form: 1.2/50 μ s according to DIN IEC 60 060-1)			
	I	II	III	IV
50	0.33	0.50	0.80	1.5
100	0.50	0.80	1.5	2.5
150	0.80	1.5	2.5	4.0
300	1.5	2.5	4.0	6.0
600	2.5	4.0	6.0	8.0

Table 00.02

Rated impulse withstand voltage in kV	Minimum clearances in mm up to 2000 m above sea level ¹⁾			
	Case A (Inhomogeneous field ³⁾)		Case B (Homogeneous field ²⁾)	
	Pollution degree		Pollution degree	
	1	2	1	2
0.33	0.01	0.2	0.01	0.2
0.50	0.04		0.04	
0.80	0.1		0.1	
1.5	0.5	0.5	0.3	0.3
2.5	1.5	1.5	0.6	0.6
4.0	3	3	1.2	1.2
6.0	5.5	5.5	2	2
8.0	8	8	3	3

¹⁾ For higher altitudes see table 2b from DIN VDE 0110 for multiplying factors.
²⁾ Verification by an impulse voltage test is required if the clearance is less than the value specified for case A.
³⁾ Point to plane.

Table 00.03 a. Single phase, three or two wire AC or DC systems

Table 00.03 b. Three phase, four or three wire AC systems

Nominal voltage of supply system ¹⁾	Rated voltage in V		Nominal voltage of supply system ¹⁾	Rated voltage in V		
	Phase-to-phase All systems (between conductors of different polarity for U_-)	Phase-to-earth		Phase-to-phase	Phase-to-earth	
$U_{r.m.s.}$ or U_- in V	$U_{r.m.s.}$ or U_-	$U_{r.m.s.}$ or U_-	$U_{r.m.s.}$ in V	$U_{r.m.s.}$	$U_{eff.s.}$	$U_{eff.s.}$
12.5	12.5	–	60	63	32	63
24	25	–	110	125	80	125
25	–	–	120	–	–	–
30	32	–	127	160	–	160
42	–	–	150 ²⁾	200	125	200
48	50	–	220	250	160	250
50 ²⁾	–	–	230	–	–	–
60	63	–	240	320	–	320
60/30	63	32	300 ²⁾	–	–	–
100 ²⁾	100	–	380	400	250	400
110	125	–	400	500	250	500
120	–	–	415	500	320	500
150 ²⁾	160	–	440	500	320	500
220	250	–	480	630	400	630
220/110	250	125	500	630	–	630
240/120	–	–	575	630	–	630
300 ²⁾	320	–	600 ²⁾	630	–	630
440/220	500	250	660	630	400	630
600 ²⁾	630	–	690	–	–	–

¹⁾ This voltage can be the same as the rated voltage of the equipment.
²⁾ These values correspond to the values of table 00.01.
 In countries where both star and delta, earthed and unearthed supply systems are used the values for delta systems only should be used. Systems earthed across impedances are treated as unearthed systems.

Table 00.04

Rated voltage $U_{r.m.s.}$ or U_- in V	12.5	25	32	50	63	80	100	125	160	200	250	320	400	500	630	800	1000
Minimum creepage distance in mm																	
Degree of pollution 1	0.09	0.125	0.14	0.18	0.2	0.22	0.25	0.28	0.32	0.42	0.56	0.75	1	1.3	1.8	2.4	3.2
Degree of pollution 2	0.42	0.5	0.53	1.2	1.25	1.3	1.4	1.5	1.6	2	2.5	3.2	4	5	6.3	8	10

Performance level 3 as per IEC 60 603-2

50 mating cycles then visual inspection.
No gas test.
No functional impairment.

Part No. explanation 09 7...

Performance level 2 as per IEC 60 603-2

400 mating cycles.
200 mating cycles then 4 days gas test using 10 ppm SO₂.
Measurement of contact resistance.
200 mating cycles then visual inspection. No abrasion of the contact finish through to the base material.
No functional impairment.

Part No. explanation 09 6...

Performance level 1 as per IEC 60 603-2

500 mating cycles.
250 mating cycles then 10 days gas test using 10 ppm SO₂.
Measurement of contact resistance.
250 mating cycles then visual inspection. No abrasion of the contact finish through to the base material.
No functional impairment.

Part No. explanation 09 2...

Performance level 2 as per IEC 61 076-4-113

250 mating cycles.
125 mating cycles then 4 days gas test using 10 ppm SO₂.
Measurement of contact resistance.
125 mating cycles then visual inspection. No abrasion of the contact finish through to the base material.
No functional impairment.

Part No. explanation 02 2...

Performance level 1 as per IEC 61 076-4-113

500 mating cycles.
250 mating cycles then 10 days gas test using 10 ppm SO₂.
Measurement of contact resistance.
250 mating cycles then visual inspection. No abrasion of the contact finish through to the base material.
No functional impairment.

Part No. explanation 02 1...

Other plating finishes available on request.

Mating conditions

To ensure reliable connections and prevent unnecessary damage, please refer to the application data diagrams.

These recommendations are set out in IEC 60 603-2.

The connectors should not be coupled and decoupled under electrical load.

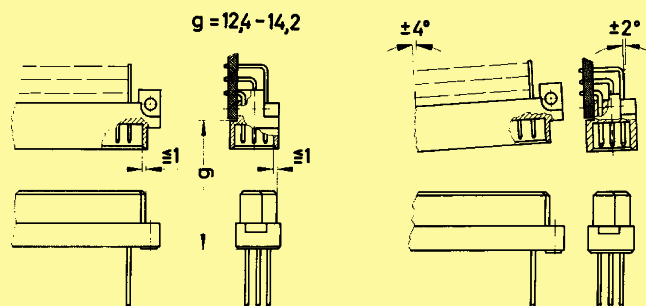

Soldering the male connectors into pcb's

Male connectors should be protected when being soldered in a dip, flow or film soldering baths. Otherwise, they might become contaminated as a result of soldering operations or deformed as a result of overheating.

- ① For prototypes and short runs protect the connectors with an industrial adhesive tape, e.g. Tesaband 4331 (www.tesa.de). Cover the underside of the connector moulding and the adjacent parts of the pcb as well as the open sides of the connector. This will prevent heat and gases of the soldering apparatus from damaging the connector. About 140 + 5 mm of the tape should suffice.
- ② For large series a jig is recommended. Its protective cover with a fast action mechanical locking device shields the connectors from gas and heat generated by the soldering apparatus. As an additional protection a foil can be used for covering the parts that should not be soldered.
- ③ For prototypes and short runs the protection described under point ① can be replaced by a solder protection cap. This cap can be ordered under the part no. 09 02 000 9935.



Adhesive tape or protection cap

① + ③

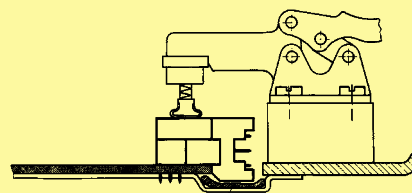

Intermediate foil

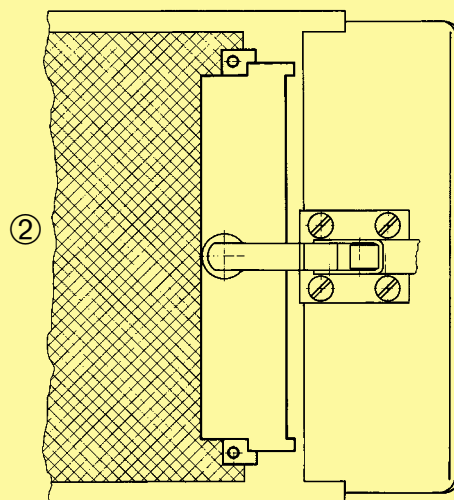

Design of connectors

- Standard fixing arrangement
- Standard positions for pcb's and connectors provide a modular system in the card frame and a standard front panel system.
- Standard wiring matrix on the connection side for female connectors built up on a 2.54 mm (0.1" centres) grid. (This facilitates automatic wiring).
- Printed circuit boards with standard dimensions 100 x 160 resp. 233.4 x 160 mm as set out in DIN EN 60 297-3 standard sizes 3 U and 6 U.

Building up card frame systems

In the basic frame unit according to DIN EN 60297-3 pcb's are inserted from the front and make contact with the connectors fitted to the back. This basic arrangement gives the following advantages:

- When using conventional connectors on the back of the card frames, space is left above, below and in the middle along the horizontal line of the frame which can be used to fit extra connectors for cross connection or making plug connections by means of flying lead connectors.
- Using the HARTING system one can also connect flying lead connectors onto the front of the frame or even onto the inside of the back of the frame. This means that external equipment can easily be monitored, controlled or tested from the card frame itself.

Complementary components

All connectors can be supplied with a complete range of accessories. These can be fitted above or below the wiring plane on the back of the card frame or on the front of the card frame. These connectors and accessories provide a complete connector system suitable for commonly used wiring techniques.

- The flying lead connector consists of a connector with crimp or solder contacts and a shell housing. The flying lead connector is latched or retained in position using screw fixings and is compatible with a corresponding male connector and interface connectors I and U.
- Fixing brackets prohibit the withdrawal of the pcb when a flying lead connector is used on the front side of the card frame.
- The interface connector I has blade contacts on the plug side and solder pins, wrap posts or crimp terminals on the termination side. It replaces the female connector type F fitted into the frame and allows interfacing to the internal wiring with the help of the flying lead connector on the back of the card frame unit.
- On the one plane the interface connector U has male contacts that are compatible with the flying lead connector. On the other plane it has wrap posts for interfacing to the internal wiring of the card frame. It can be mounted on the back of the card frame above or below other connectors arranged upright. Its wrap posts follow the same pitch as other connectors therefore allowing automated wiring. By using the U connector with the flying lead connector plug-in connections between the card frame and the peripheral equipment/ outlying stations are made easy.

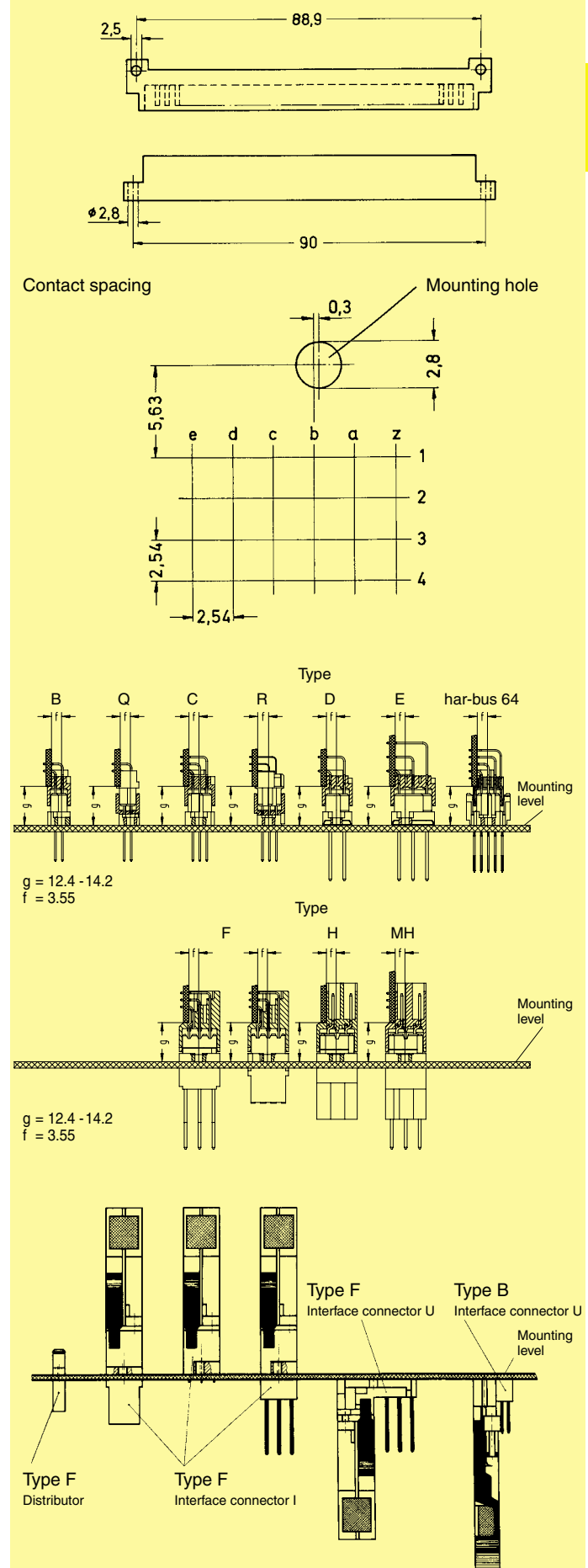

General information

Type	B, Q		C, R
Wiring side (Rear side)	Input access from the front side via a female connector	Input access from the wiring side via a female connector	Input access via a female connector
Soldering technique for a flexible wiring			
Soldering technique for pcb Press-in technique for pcb			
Crimp connections			
Wrapped connections posts 0.6 x 0.6 mm 1 x 1 mm			
Middle section 			
Front side 			
<p>1) Screw fixing (cheesehead screw M 2.5 x 16 + nut) 09 02 000 9909</p> <p>2) Screw fixing (cylindric screw M 2.5 x 22) 09 02 000 9923</p> <p>3) 2 x screw fixing (cylindric screw M 2.5 x 25 DIN EN ISO 1207 + nut M 2.5 DIN EN ISO 4032)</p> <p>4) Fixing brackets for latching and screw fixing</p> <p>5) Screw length depends on the pcb thickness</p>			
			<p>f = female connector</p> <p>m = male connector</p> <p>R = right hand</p> <p>L = left hand</p>

<i>harbus</i> [®] 64	D	E			
<p>Input access from the front side via a female connector</p>	<p>Input access from the front side via a female connector</p> <p>Piggyback connector</p>	<p>Input access via a female connector</p> <p>Piggyback connector</p>			
			<p>I element</p>		
	<p>1 x 1 mm</p>	<p>1 x 1 mm</p>			
<p>Y =</p>	<p>Combinations</p>	<p>Fixing bracket c for male connectors</p> <p>Multiple fixing</p>	<p>Single fixing</p>	<p>I element</p>	<p>U element</p>
<p>Housing C</p>	<p>latchable</p>	<p>latch and screw fixing (M 2.5 x 16)</p>	<p>latch and screw fixing</p>	<p>latch and screw fixing</p>	<p>screw fixing</p>
<p>Housing G</p>	<p></p>	<p>screw fixing</p>	<p></p>	<p></p>	<p></p>

General information

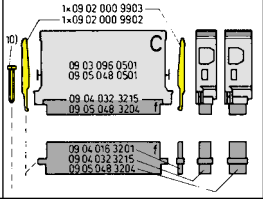
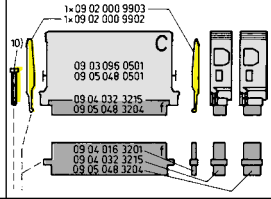
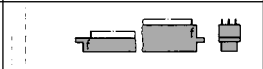
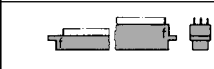
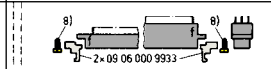
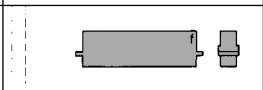
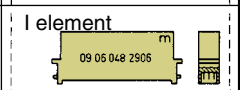
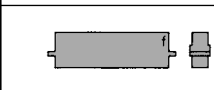
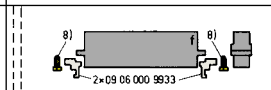
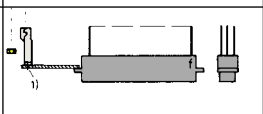
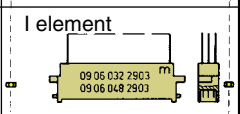
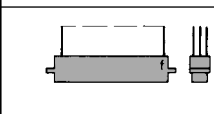
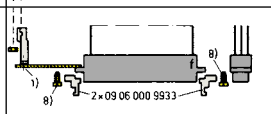
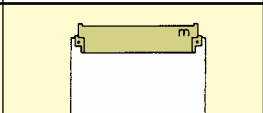
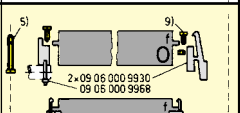
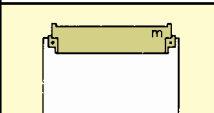
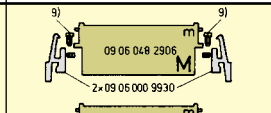
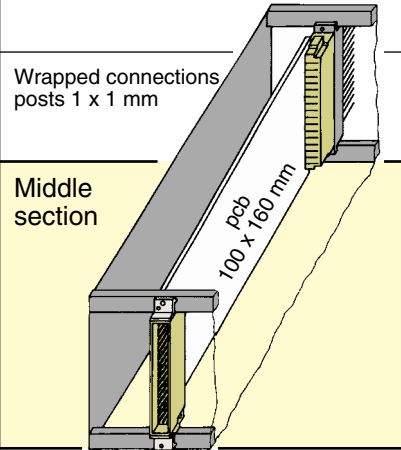
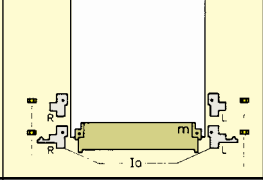
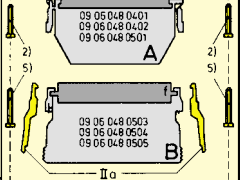
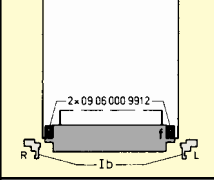
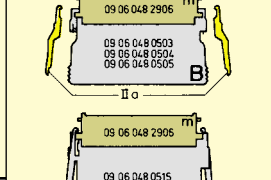
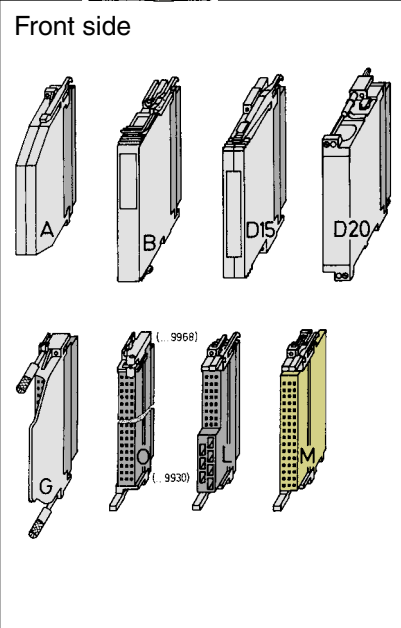
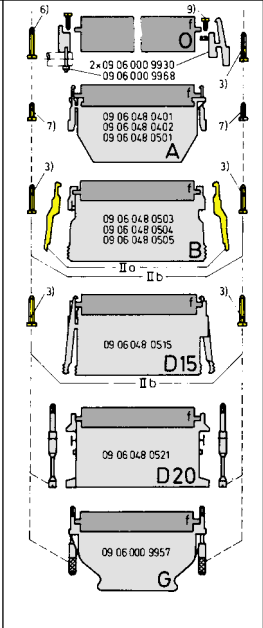
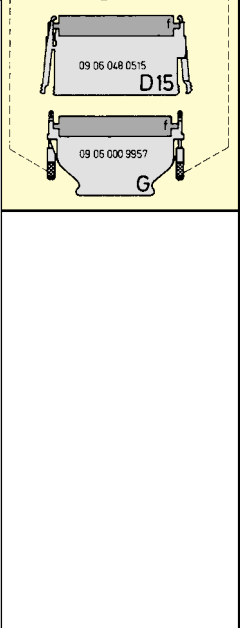
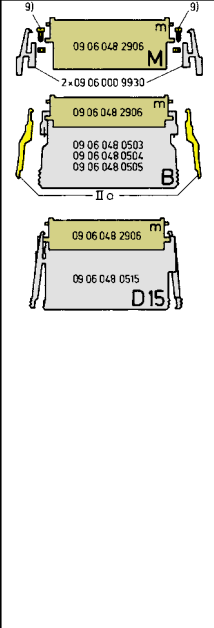
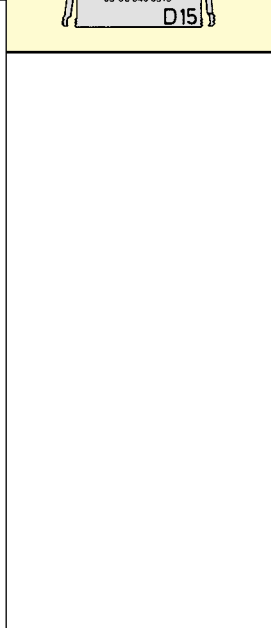
Type	F			
Wiring side (Rear side)	Input access via a female connector			Output from the front side via a male connector
	Piggyback connector 			Piggyback connector 
Soldering technique for a flexible wiring				
Soldering technique for pcb Press-in technique for pcb		I element 		
Crimp connections		I element 		
Wrapped connections posts 1 x 1 mm		I element 		
Middle section 				
Front side 				

F	H	MH 24 + 7																																																										
<p>Input access from the wiring side via a female connector</p>	<p>Input access from the front side via a female connector</p>	<p>Input access from the front side via a female connector</p>	<p>Ia</p> <table border="1"> <thead> <tr> <th rowspan="2">Combinations</th> <th colspan="2">Fixing bracket a for male connectors</th> <th colspan="2">Fixing bracket b for male connectors</th> </tr> <tr> <th>Multiple fixing</th> <th>Single fixing</th> <th>Multiple fixing</th> <th>Single fixing</th> </tr> </thead> <tbody> <tr> <td>Housing A</td> <td colspan="2">latch (M 2.5 x 12) and screw fixing</td> <td colspan="2">latchable</td> </tr> <tr> <td>Housing B</td> <td colspan="2"></td> <td colspan="2">latch (M 2.5 x 20) and screw fixing</td> </tr> <tr> <td>Housing D15</td> <td colspan="2"></td> <td colspan="2">latch (M 2.5 x 20) and screw fixing</td> </tr> <tr> <td>Housing D20</td> <td colspan="2"></td> <td colspan="2">screw fixing</td> </tr> <tr> <td>Housing G</td> <td colspan="2"></td> <td colspan="2">screw fixing</td> </tr> <tr> <td>(...9930)</td> <td colspan="2"></td> <td colspan="2">latch (M 2.5 x 20) and screw fixing</td> </tr> <tr> <td>Comb. O (...9968)</td> <td colspan="2"></td> <td colspan="2">screw fixing</td> </tr> <tr> <td>(...9930)</td> <td colspan="2"></td> <td colspan="2">latch (M 2.5 x 20) and screw fixing</td> </tr> <tr> <td>Comb. L (...9968)</td> <td colspan="2"></td> <td colspan="2">screw fixing</td> </tr> </tbody> </table>				Combinations	Fixing bracket a for male connectors		Fixing bracket b for male connectors		Multiple fixing	Single fixing	Multiple fixing	Single fixing	Housing A	latch (M 2.5 x 12) and screw fixing		latchable		Housing B			latch (M 2.5 x 20) and screw fixing		Housing D15			latch (M 2.5 x 20) and screw fixing		Housing D20			screw fixing		Housing G			screw fixing		(...9930)			latch (M 2.5 x 20) and screw fixing		Comb. O (...9968)			screw fixing		(...9930)			latch (M 2.5 x 20) and screw fixing		Comb. L (...9968)			screw fixing	
Combinations	Fixing bracket a for male connectors		Fixing bracket b for male connectors																																																									
	Multiple fixing	Single fixing	Multiple fixing	Single fixing																																																								
Housing A	latch (M 2.5 x 12) and screw fixing		latchable																																																									
Housing B			latch (M 2.5 x 20) and screw fixing																																																									
Housing D15			latch (M 2.5 x 20) and screw fixing																																																									
Housing D20			screw fixing																																																									
Housing G			screw fixing																																																									
(...9930)			latch (M 2.5 x 20) and screw fixing																																																									
Comb. O (...9968)			screw fixing																																																									
(...9930)			latch (M 2.5 x 20) and screw fixing																																																									
Comb. L (...9968)			screw fixing																																																									
<p>I element</p>			<p>Ib</p> <table border="1"> <thead> <tr> <th rowspan="2">Combinations</th> <th rowspan="2">Fixing bracket b for female connectors Multiple fixing</th> <th>I element</th> <th>U element</th> </tr> </thead> <tbody> <tr> <td></td> <td></td> <td></td> </tr> <tr> <td>Housing A</td> <td></td> <td>(M 2.5x22) latch and (M 2.5x16) screw fixing</td> <td></td> </tr> <tr> <td>Housing B</td> <td>latchable</td> <td>(M 2.5x26) latch and (M 2.5x20) screw fixing</td> <td></td> </tr> <tr> <td>Housing D15</td> <td>latchable</td> <td>latchable</td> <td></td> </tr> <tr> <td>Housing G</td> <td></td> <td>screw fixing</td> <td></td> </tr> <tr> <td>(...9930)</td> <td></td> <td>latchable</td> <td></td> </tr> <tr> <td>Comb. O (...9968)</td> <td></td> <td>(M 2.5x26) screw fixing (M 2.5x20)</td> <td></td> </tr> <tr> <td>Comb. M</td> <td>latchable</td> <td></td> <td></td> </tr> </tbody> </table>				Combinations	Fixing bracket b for female connectors Multiple fixing	I element	U element				Housing A		(M 2.5x22) latch and (M 2.5x16) screw fixing		Housing B	latchable	(M 2.5x26) latch and (M 2.5x20) screw fixing		Housing D15	latchable	latchable		Housing G		screw fixing		(...9930)		latchable		Comb. O (...9968)		(M 2.5x26) screw fixing (M 2.5x20)		Comb. M	latchable																					
Combinations	Fixing bracket b for female connectors Multiple fixing	I element	U element																																																									
Housing A		(M 2.5x22) latch and (M 2.5x16) screw fixing																																																										
Housing B	latchable	(M 2.5x26) latch and (M 2.5x20) screw fixing																																																										
Housing D15	latchable	latchable																																																										
Housing G		screw fixing																																																										
(...9930)		latchable																																																										
Comb. O (...9968)		(M 2.5x26) screw fixing (M 2.5x20)																																																										
Comb. M	latchable																																																											
<p>U element</p>			<p>II</p> <table border="1"> <thead> <tr> <th rowspan="2">Housing B/D 15</th> <th colspan="2">II a</th> <th colspan="2">II b</th> </tr> </thead> <tbody> <tr> <td></td> <td></td> <td></td> <td></td> </tr> <tr> <td>09 06 048 0503</td> <td>2x</td> <td>09 06 000 9913</td> <td>and/or 2x</td> <td>09 06 000 9926</td> </tr> <tr> <td>09 06 048 0504</td> <td>1x</td> <td>{ 09 06 000 9913 09 06 000 9919</td> <td>and/or 2x</td> <td>09 06 000 9926</td> </tr> <tr> <td>09 06 048 0505</td> <td>1x</td> <td>{ 09 06 000 9913 09 06 000 9919</td> <td>and/or 2x</td> <td>09 06 000 9926</td> </tr> <tr> <td>09 06 048 0515</td> <td>-</td> <td>-</td> <td>and 2x</td> <td>09 06 000 9926</td> </tr> <tr> <td>Comb. O + L</td> <td>2x 2x</td> <td>09 06 000 9930 09 06 000 9968</td> <td>and 2x</td> <td>09 06 000 9926</td> </tr> <tr> <td>Comb. M</td> <td>2x</td> <td>09 06 000 9930</td> <td>-</td> <td>-</td> </tr> </tbody> </table>				Housing B/D 15	II a		II b						09 06 048 0503	2x	09 06 000 9913	and/or 2x	09 06 000 9926	09 06 048 0504	1x	{ 09 06 000 9913 09 06 000 9919	and/or 2x	09 06 000 9926	09 06 048 0505	1x	{ 09 06 000 9913 09 06 000 9919	and/or 2x	09 06 000 9926	09 06 048 0515	-	-	and 2x	09 06 000 9926	Comb. O + L	2x 2x	09 06 000 9930 09 06 000 9968	and 2x	09 06 000 9926	Comb. M	2x	09 06 000 9930	-	-															
Housing B/D 15	II a		II b																																																									
09 06 048 0503	2x	09 06 000 9913	and/or 2x	09 06 000 9926																																																								
09 06 048 0504	1x	{ 09 06 000 9913 09 06 000 9919	and/or 2x	09 06 000 9926																																																								
09 06 048 0505	1x	{ 09 06 000 9913 09 06 000 9919	and/or 2x	09 06 000 9926																																																								
09 06 048 0515	-	-	and 2x	09 06 000 9926																																																								
Comb. O + L	2x 2x	09 06 000 9930 09 06 000 9968	and 2x	09 06 000 9926																																																								
Comb. M	2x	09 06 000 9930	-	-																																																								
			<p>1) Fixing brackets for latch and screw fixing 2) Screw M 2.5 x 22 belongs to supply of I elements, nut M 2.5 DIN EN ISO 4036 does not belong to scope of supply 3) Screw fixing (cheesehead screw M 2.5 x 20 + nut) 09 06 000 9926 4) Screw fixing (cheesehead screw M 2.5 x 16 + nut) 09 02 000 9909 5) Cheesehead screw (M 2.5 x 26) 09 06 000 9955, nut M 2.5 DIN EN ISO 4036 does not belong to scope of supply 6) Screw M 2.5 x 20 belongs to the junction element, hexagonal nut M 2.5 DIN EN ISO 4036 does not belong to scope of supply</p> <p>Following items don't belong to scope of supply</p> <p>7) Screw M 2.5 x 12 and nut M 2.5 DIN EN ISO 4036 8) Screw M 2.5 x 8 9) Screw M 2.5 x 8 and nut M 2.5 DIN EN 4032 10) Screw M 2.5 x 25 and nut M 2.5 DIN EN 4032</p> <p>f = female connector m = male connector R = right hand L = left hand</p>																																																									

The automated insertion of components into pcb's is increasing.

To meet this market demand, HARTING has developed connectors which can be assembled and fixed to the pcb in one process.

To fix the connectors HARTING offers snap-in clips as well as kinked pins.

Snap-in clips

In the soldering process, all component terminations including the snap-in clips are soldered and therefore mechanically secured. This provides mechanical protection for the soldered contacts during mating and unmating of the connector.

Mouldings with snap-in clips offer the following advantages:

- Cost reduction when compared with the screw or rivet assembly methods due to the soldering of the clip along with other components in one process.
- The orientation of the clip after soldering in the plated through hole provides mechanical protection against the tensile forces arising from the mating and unmating of the connector.

It is possible to supply the majority of male and female connectors with solder termination with snap-in clips (existing articles see product pages).

For pcb thickness
 $1.6 \pm 0.2 \text{ mm}$
 $\text{Ø} = 2.8^{+0.1} \text{ mm}$

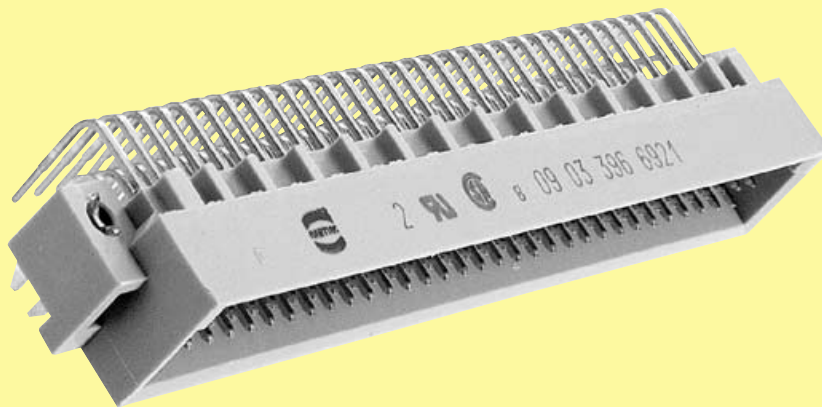

Mounting force
 40 - 60 N

For pcb thickness
 $1.6 - 4.0 \text{ mm}$
 $\text{Ø} = 2.8^{+0.1} \text{ mm}$

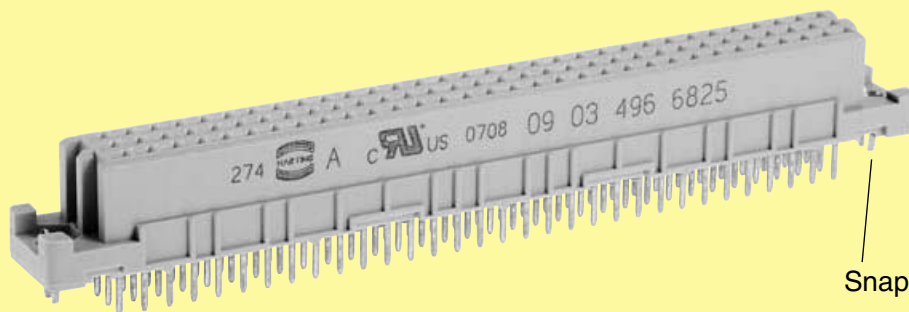

Snap-in clip

Kinked pins

Before and during soldering, the connectors are fixed onto the pcb with four kinked contacts located in the rows a and c, e.g. the positions a1, c1, a32 and c32 for a fully loaded connector.

Connectors with kinked pins are a reliable alternative for female connectors with straight terminations because no additional elements like screws, rivets or clips are necessary.

Explanations see chapter 01.

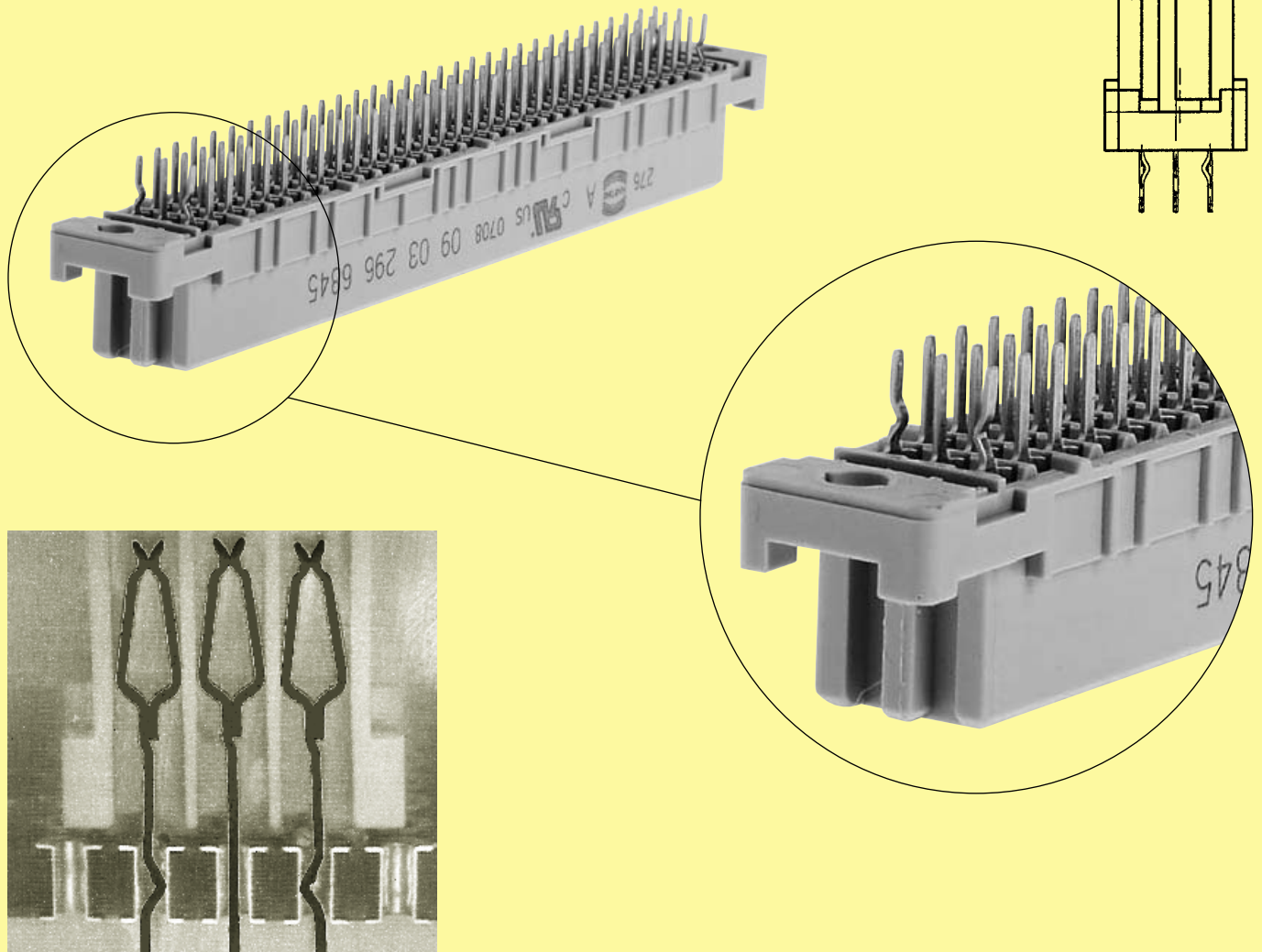

Cross section of a connector with kinked contacts assembled to a pcb

Dimension of the plated through hole [mm]	Mounting force [N]	Retention force [N]
0.94	55	35
1.09	11	7

Typical measurements for a pcb of 2.4 mm thickness.

Solder pins for printed circuit boards
 explanation see page 00.15

Solder pins for reflow soldering
 explanation see chapter 05

Solder lugs for discrete wiring
 explanation see page 00.15

Wrap posts for automatic wiring techniques
 explanation see page 00.15

Press-in technology for printed circuit boards
 explanation see chapter 04

Crimp contacts for flexible wiring, selective loading and ease of replacement
 explanation see page 00.16

Insulation displacement contacts for mass termination of flat cable

Faston blades for higher power discrete wiring

Cage-clamp contacts provide low cost connection for solid or stranded wires

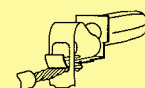
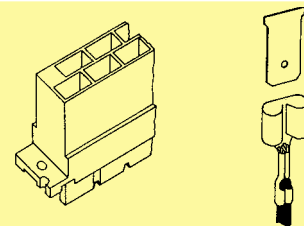
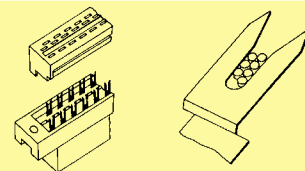
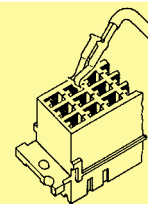
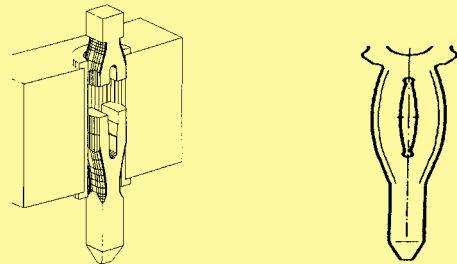
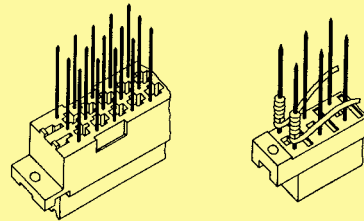
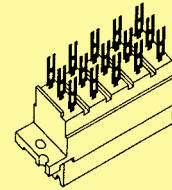
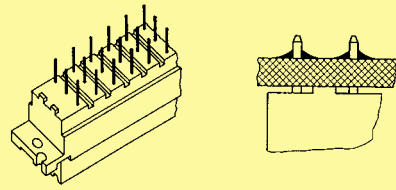

Solder connection

The term "soldering" is defined in DIN 8505:

"Soldering is a method of connecting metallic materials using an additional melting metal, if necessary with the assistance of a flux and/or protective gas. The melting temperature of the solder must lie beneath the minimum melting temperature of the base metals being connected. These base metals shall be tinned without melting themselves."

Soft solders commonly used on electronic equipment are to DIN 1707-100. Today's lead free solders have a melting range between 217 °C and 227 °C depending on the composition of the alloy. For soldering metallic materials the flux is defined in DIN EN 29454-1. Tests are explained in DIN 8526. For soldering male connectors into printed circuit boards, see recommendations for soldering on page 00.06.

Wrapped connection

This technique permits high wiring density and takes over where other techniques would take up too much real estate. As a result of this process, there is a great time saving factor and cost per connection is relatively low when large numbers of connections are to be made.

When wires are correctly wrapped onto a precision manufactured rectangular post produced to the recommended specifications, one can state the following:

A low resistance, mechanically strong and highly reliable connection is made which is unaffected by normal climatic or temperature changes.

Production of wrapped connections and associated material are defined in DIN EN 60352-1.

Wrapping techniques

Standard wrap

Only the non-insulated part of the wire is wrapped around the post. This means that the size of the wrapped connection is kept to the very minimum.

Modified wrap

The top part of the wrapped connection is made using the cable conductor as stated above but an extra turn is made at the bottom. For this turn insulation is also wrapped around the post to give a great mechanical strength to the joint and also to provide insulation between adjacent posts.

Wrapping tools

To produce quality wrapped connections one must use a special wrapping tool, which can be pneumatic, electric or hand operated. Such tools have interchangeable wrapping heads and sleeves to suit the particular size of the wrap post being used.

The choice of accessories for these wrapping tools depends from the wrapping technique, the size of the wrap post itself and the conductor and insulation diameters of the wire.

The adjacent tables show the maximum amount of wrapped connections that can be placed on the wire wrap post (in acc. to IEC 60352-1).

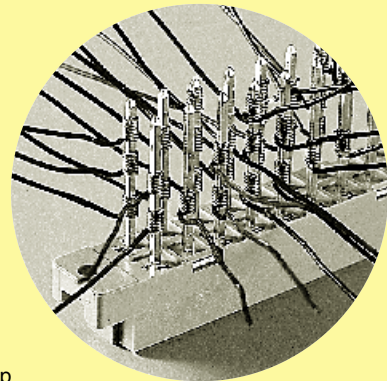

Standard wrap

Wire diameter [mm]						
0.25	0.32	0.4	0.5	0.65	0.8	1.0
max. allowed wire Ø incl. wire insulation [mm]						
0.7	0.9	1.17	1.27	1.32	1.5	1.78

Valid for standard wrap

Dimension of wire wrap post [mm]	Length of wire wrap post [mm]	possible wrap connections per wrap post						
		7	7	6	5	4	4	
0.6 x 0.6	13	6	5	4	4	4	3	2
0.6 x 0.6	17	8	6	6	5	5	4	3
1 x 1	20	10	7	7	6	6	5	4
1 x 1	22	11	8	7	7	6	5	4

Table 00.05

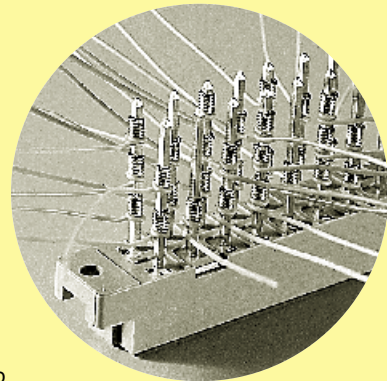

Modified wrap

Wire diameter [mm]						
0.25	0.32	0.4	0.5	0.65	0.8	1.0
max. allowed wire Ø incl. wire insulation [mm]						
0.7	0.9	1.17	1.27	1.32	1.5	1.78

Valid for modified wrap

Dimension of wire wrap post [mm]	Length of wire wrap post [mm]	possible wrap connections per wrap post						
		7	7	6	5	4	4	
0.6 x 0.6	13	4	3	2	2	2	2	1
0.6 x 0.6	17	5	4	3	3	3	2	2
1 x 1	20	6	4	4	3	3	3	2
1 x 1	22	6	5	4	4	4	3	2

Table 00.06

Crimp connection

A perfect crimp connection is gastight and therefore corrosion free. It is equivalent to a cold weld of the connected parts. For this reason, major features in achieving high quality crimp connections are the design of the crimping areas of the contact and of course the crimping tool itself. Wires to be connected must be carefully matched to the correct size of crimp contacts. If these basic requirements are met, users will be assured of highly reliable connections with a low contact resistance and a high resistance against corrosion.

The economical and technical advantages are:

- Constant contact resistance as a result of an unvariable crimp connection quality
- Corrosion free connections as a result of cold weld action
- Preparation of harnessing with crimp contacts already fitted
- More economic cable connection

Requirements for crimp connections are set out in DIN EN 60352-2.

Pull out force of stranded wire

An essential consideration for a good quality of crimp connection is the mechanical retention of the wire in the crimp contact. As set out in DIN EN 60352-2 the pull out force of the wire from the crimp must be at least 60 % (at 0.75 mm²) of the breaking force of the wire itself.

The adjacent diagram shows tensile strength plotted against wire cross sectional area. From this you can see the relationship between the breaking strength of wires and the force necessary to destroy HARTING crimp connections.

- ① Tensile strength of stranded wire
- ② Pull out force of wires from HARTING crimp contacts

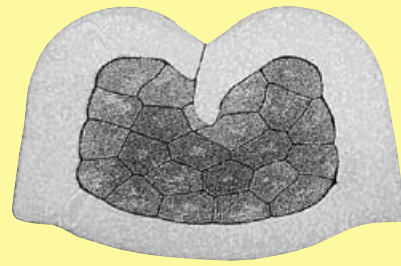

Crimp cross-section

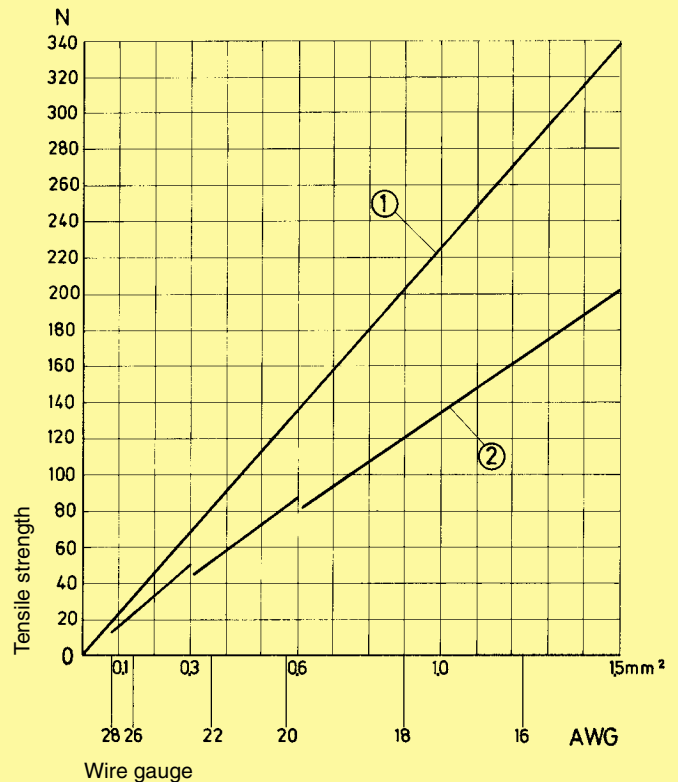

Crimping tools

Crimping tools (hand operated or automatic) are carefully designed to guarantee a symmetrical deformation of the crimping area of the contact and the wire through the high pressure forming parts of the tool. The locator automatically engages the crimp contact and the wire at the correct point in the tool. The wire insulation can also be included as a secondary feature of some crimp contacts to care for additional mechanical strength.

The ratchet in the tool performs 2 functions:

- ① It prevents insertion of the crimp into the tool for crimping before the jaws are fully open
- ② It prevents the tool from being opened before the crimping action is completed

A quality crimp connection can be achieved with this crimping system.

The adjacent sketches show important features of the HARTING hand crimping tool.

The HARTING automatic crimping tool uses bandoliered contacts.

The machine strips insulation from the wire and then crimps the contact. Both the crimping area and the insulation support are independently adjustable to facilitate the use of any wire type with dimensions within the stated crimp capacity.

