

The highest data rates in combination with perfect shielding characterize the *har-link*® connector. This way data can be passed on optimally within the control cabinet. The locking mechanism ensures a vibration-proof connection and easy-to-install handling at a minimum size and maximum options for combination with other units.

HARTING offers assembled system cables with shielded or unshielded twisted pairs for the *har-link*® connector family.

Application profile:

CONNECTION TYPE		ENVIRONMENT		APPLICATION							
Board to Board	Cable/Wire to Board	IP 20	IP 65 / IP 67	Data	Signal	Power	high performance				
							Data transfer rate	Shielding	Number of contacts, contact density	Voltage, working current	
Cable termination			PCB termination			Application standard					
<i>Han-Quick Lock</i> ®	IDC	Crimp	THT	SMC	SMT						
Screw	Cage clamp	Axial screw	Press-in								
						Separate housing		Integrated housing			

CONTENTS	PAGE
<i>har-link</i> ® connector system – introduction	07.02
<i>har-link</i> ® connector system – general information	07.04
Technical characteristics	07.05
Male and female connectors	07.06
Accessories and cable assemblies	07.07

Tooling see chapter 20

METRIC *har-link*[®] INTERFACE CONNECTORS IN 2.0 mm PITCH

HARTING's modular interface connector system, *har-link*[®] in 2.0 mm pitch, allows data transfer rates up to 2 Gbit/s. The *har-link*[®] connector system of HARTING complies with the requirements of IEC 61076-4-107 and is a compact and robust PCB-to-cable interface with excellent data transmission properties.

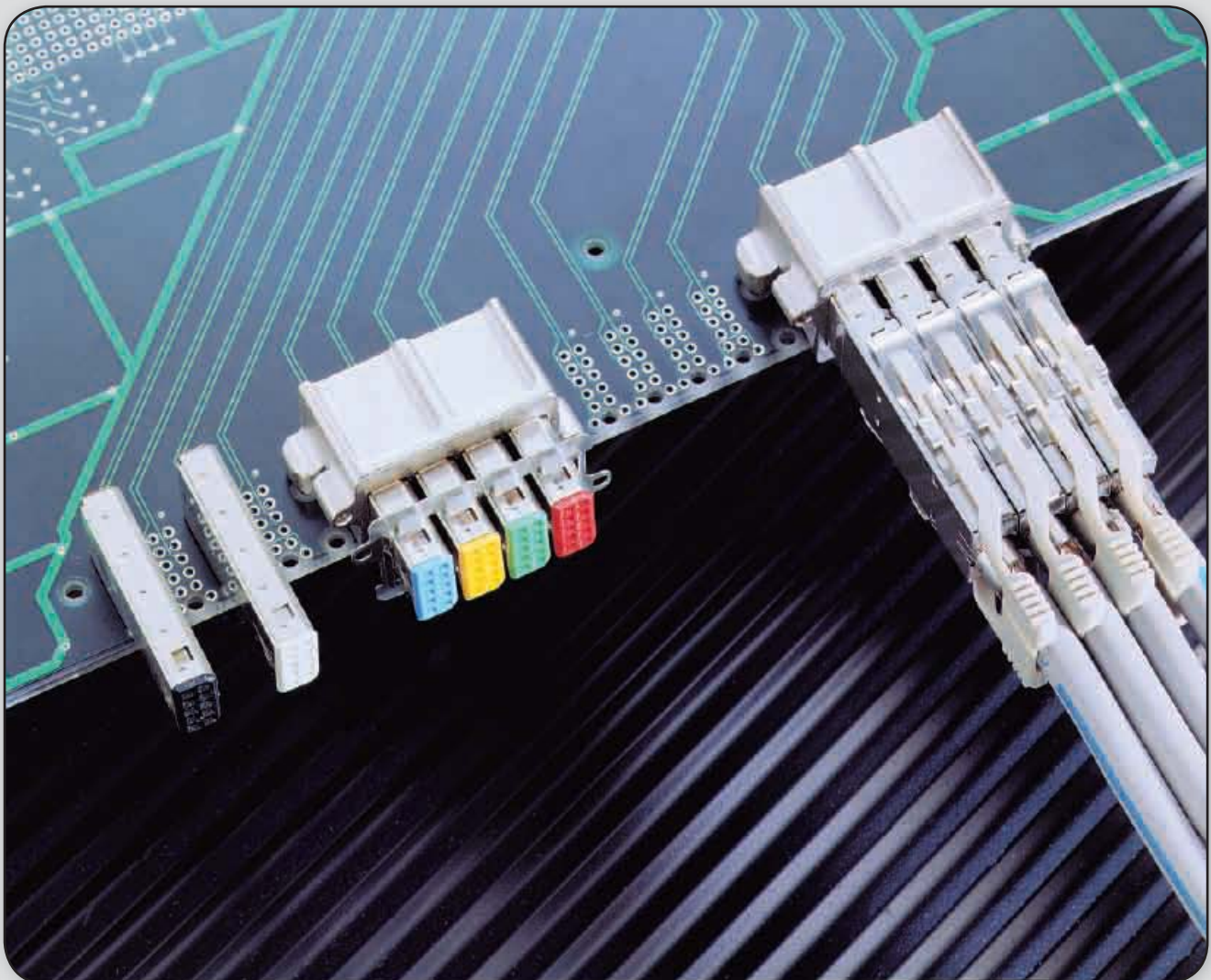
All dimensions of the *har-link*[®] connector are in accordance with IEC 917 and IEEE P 1301 specifications, allowing an easy implementation into both metric and inch-based systems. *har-link*[®] also supports hot plugging as required by modern bus systems such as CompactPCI, S-bus and VME.

har-link[®] allows data transmission up to 2 Gbit/s per pair and is therefore perfectly suited for modern transmission protocols such as Low Voltage Differential Signals (LVDS).

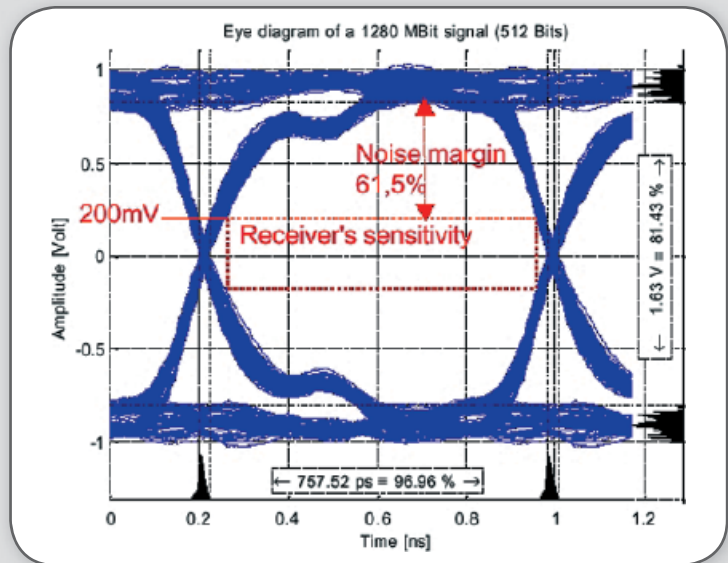
The thorough EMI shielding of the *har-link*[®] connector is a guarantee of its superior performance in the EMI-polluted environment.

The high temperature resistant material of the female *har-link*[®] connector supports reflow soldering.

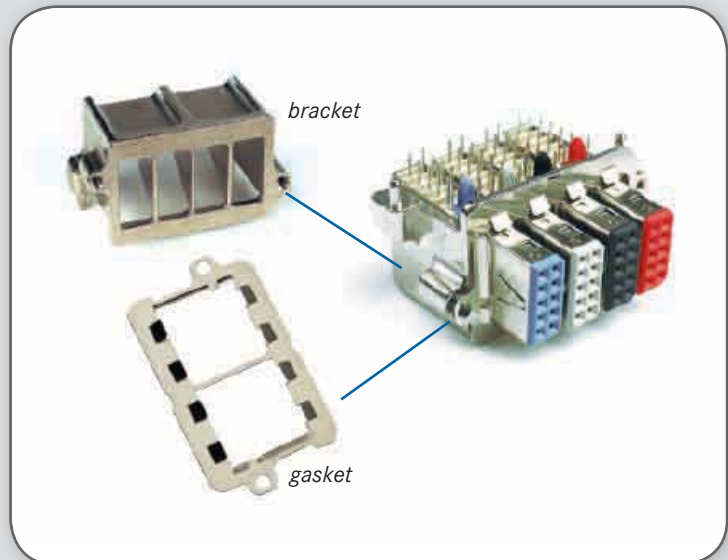
In addition, HARTING provides cable assemblies. A crimping tool range for terminating male *har-link*[®] connectors is also available.



- Data transmission up to 2 Gbit/s
- Is perfectly suited for modern transmission protocols such as Low Voltage Differential Signals (LVDS)



- A screening attenuation of more than 50 dB up to 1 GHz
- The high temperature resistant material of the female *har-link*® connector supports reflow soldering



har-link

- Shielding with integrated locking levers
- Due to the locking levers on both sides of the male connector, the connection withstands a pulling force up to 80 N



The **har-link**® connector system of HARTING complies with the requirements of IEC 61076-4-107 and is a compact and robust pcb-to-cable interface with excellent data transmission properties for high-speed networking and telecommunications.

All dimensions of the **har-link**® connector are in accordance with IEC 917 and IEEE P 1301 requirements, which allows for easy implementation into both metric and inch-based systems. In addition, **har-link**® supports hot plugging as required by modern bus systems such as CompactPCI, S-bus and VME.

har-link® allows data transmission up to 2 Gbit/s per pair and is therefore perfectly suited for modern transmission protocols such as Low Voltage Differential Signals (see Fig. 1). The design of the **har-link**® connector allows differential pairs to be placed horizontally (parallel to the pcb), thus reducing the skew at high frequencies and considering high signal integrity.

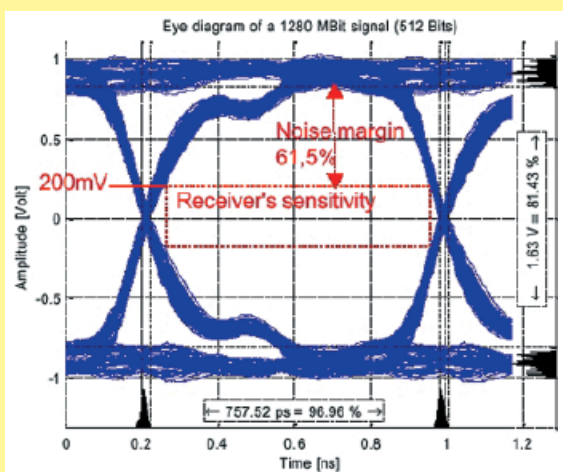


Fig. 1: Eye diagram of a 1280 MBit signal (512 Bits)

The metal shells of the **har-link**® connector are a guarantee for its superior performance in the EMI-polluted environment (see Fig. 2).



Fig. 2: 360° screened-can construction with locking levers

To reach a screening attenuation of more than 50 dB up to 1 GHz, HARTING offers brackets covering each connector in conjunction with a gasket, which is compressed between the bracket and the front panel (see Fig. 3).

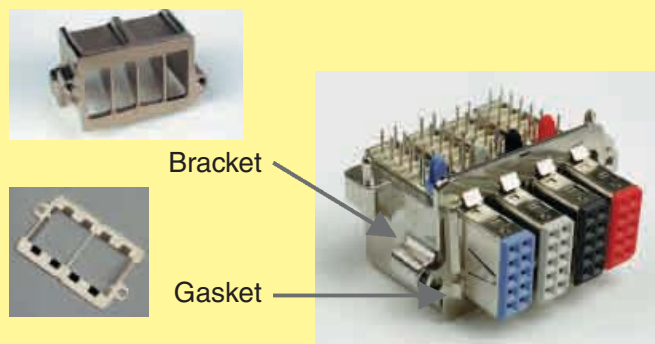


Fig. 3: 4 cavities bracket and gasket

Once plugged, the mated pair shows excellent mating safety. Due to the locking levers on both sides of the male connector, the connection withstands a pulling force of up to 80 N (see Fig. 2).

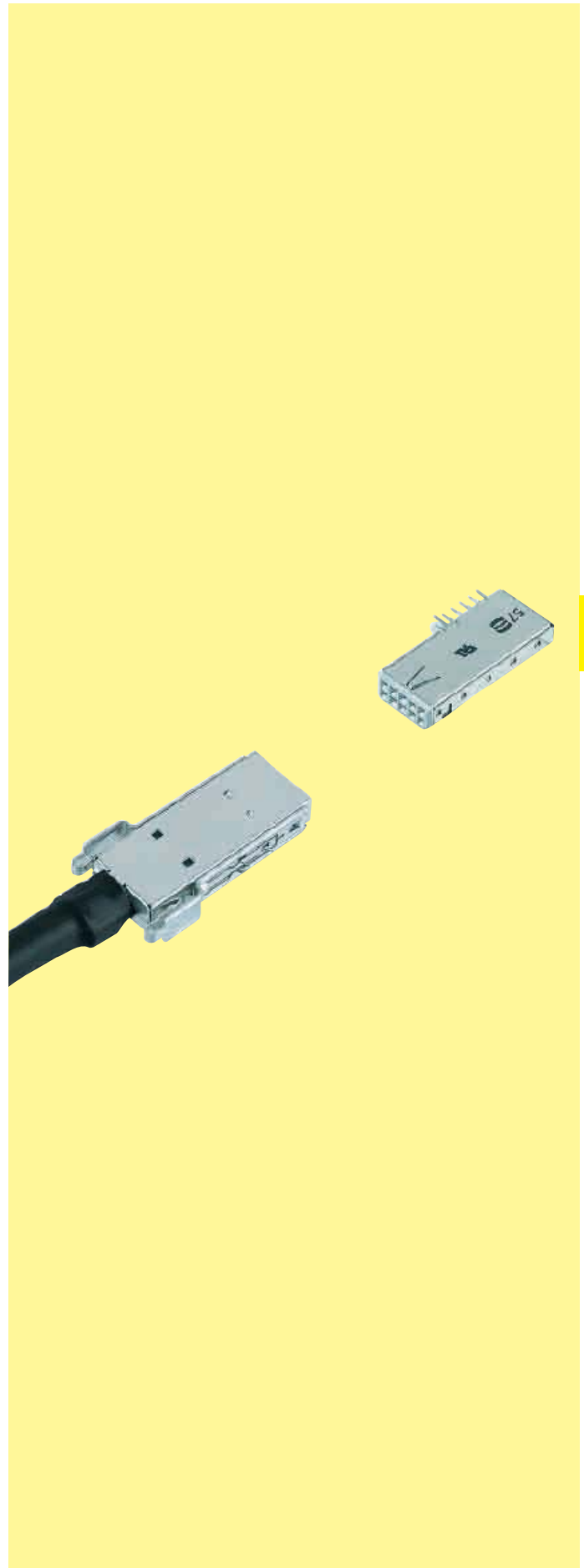
The high temperature resistant material of the **har-link**® female connector body supports the safe reflow soldering process. For easy identification of female modules, six different colours are available (see Fig. 4).

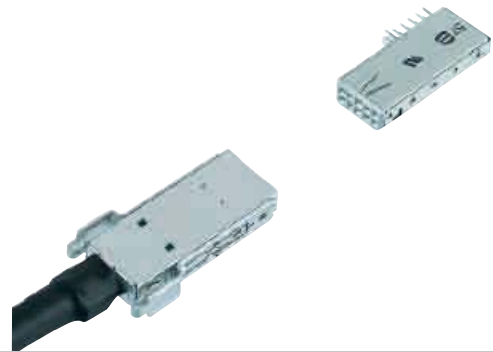


Fig. 4: Female modules

In addition to single connectors, HARTING provides cable assemblies with unshielded twisted pairs or with shielded twisted pairs for high speed applications such as IEEE 1355. A crimping tool range for terminating the male **har-link**® connectors is available.

Number of contacts	10
Approvals	IEC 61 076-4-107 UL recognized: E102079
Contact pitch Connector pitch	2 mm 6 mm
Working current	1.5 A at 70 °C
Test voltage $U_{r.m.s.}$	750 V
Contact resistance Insulation resistance	$\leq 30 \text{ m}\Omega$ $\geq 10^{10} \Omega$
Temperature range during reflow soldering	-55 °C ... + 125 °C female: max. + 260 °C for 60 s
Mating cycles	250, performance level 2
Terminations	Insulation displacement (male), AWG 28/7 - 30/7, AWG 30 solid Solder pins for $\varnothing 0.6 \text{ mm}$ min. (female)
Insertion force Withdrawal force	10 N max. / module 2 N min. / module (without locking levers)
Latching system	Locking levers
Materials	
Mouldings	Male connector: Polyester, UL 94-V0 Female connector: High temperature plastic material, UL 94-V0
Contacts	Copper alloy
Shells	Male connector: Stainless steel Female connector: Silver nickel
Contact surface Contact zone	Selectively gold-plated

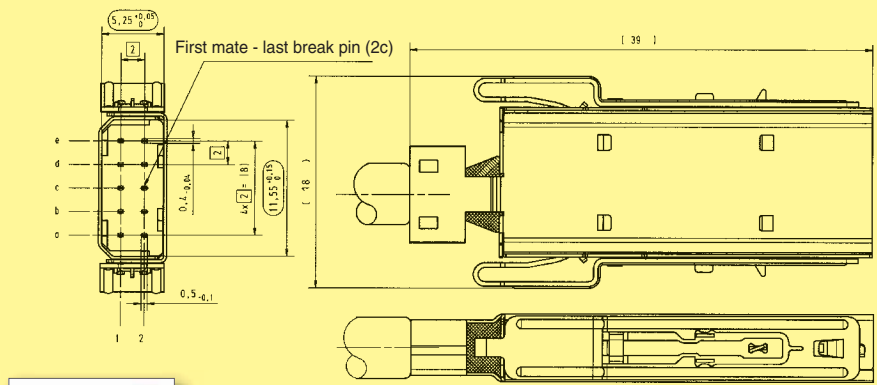




Male connectors, straight
Female connectors, angled

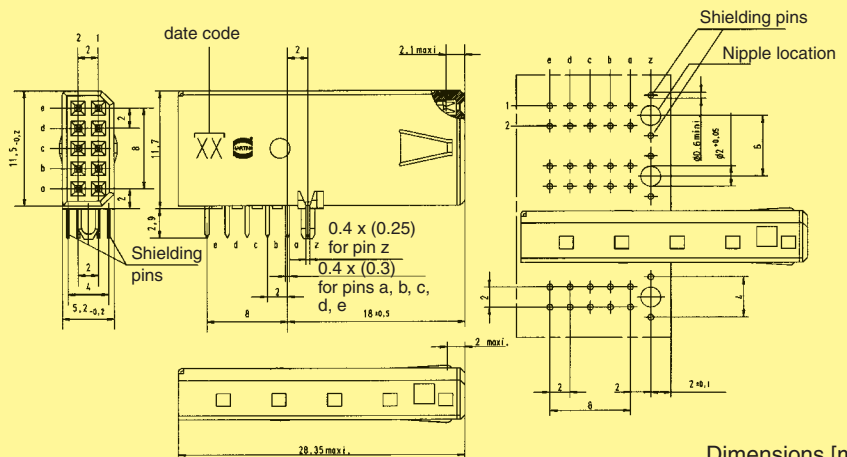
Identification	No. of contacts	Colour	Part No.
Male connector for insulation displacement	10	Black	27 11 161 8001
Female connector with solder pins	10	Beige (standard)	27 21 121 8000
	10	Red	27 21 121 8002
	10	Yellow	27 21 121 8004
	10	Green	27 21 121 8005
	10	Blue	27 21 121 8006
	10	Black	27 21 121 8010

Male connector
(delivered in piece parts)

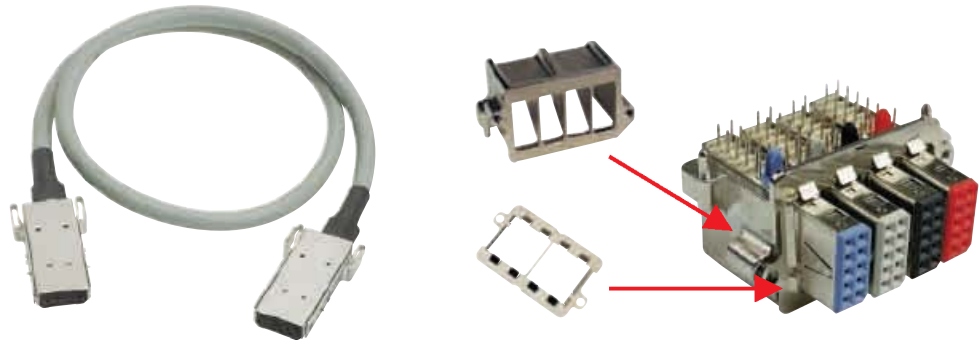


A manual for the har-link® cable free connector assembly is available in our online catalogue *HARKIS®* or on demand at your local HARTING representative.

Female connector



Dimensions [mm]

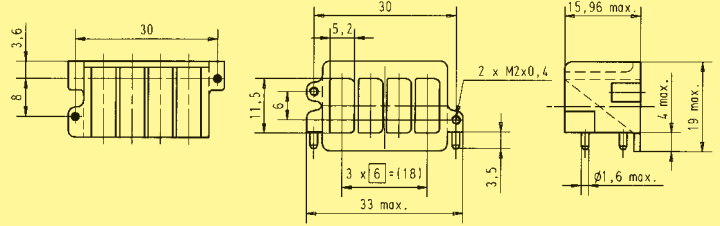


Accessories
and cable assemblies

Identification Part No. Drawing Dimensions [mm]

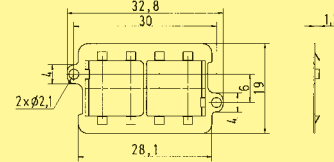
Bracket
with four cavities

27 71 040 0001



Gasket
with four cavities

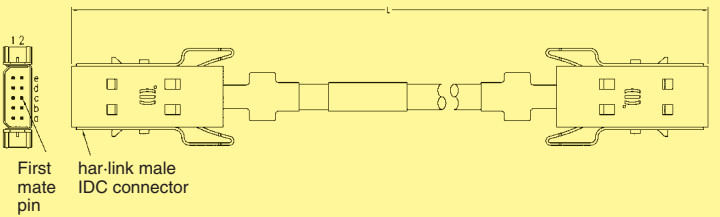
27 71 040 0002



Standard cable assembly
har-link® 10 pole
Cable: 5 twisted pairs,
AWG 28, shielded, PVC
Wiring: 1:1

Length: L = 0.5 m
L = 1.0 m
L = 2.0 m

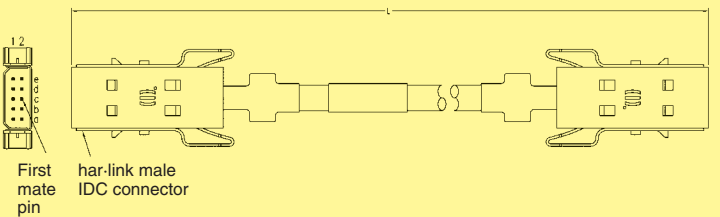
33 27 243 0500 001
33 27 243 1000 002
33 27 243 2000 003



High end cable assembly
har-link® 10 pole
Cable: 5 twisted pairs,
AWG 30, double
shielded, PVC
Wiring: 1:1

Length: L = 0.5 m
L = 1.0 m
L = 2.0 m

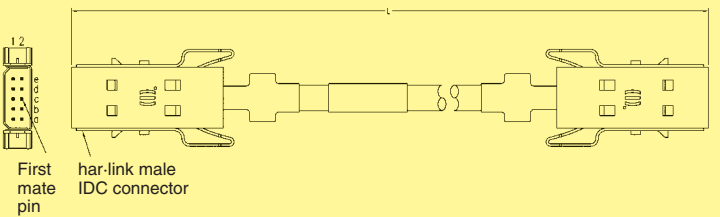
33 27 243 0500 006
33 27 243 1000 007
33 27 243 2000 008



High end cable assembly
har-link® 10 pole
Cable: 5 twisted pairs,
AWG 30, double
shielded, PVC
Wiring: acc. to IEEE 1355

Length: L = 0.5 m
L = 1.0 m
L = 2.0 m

33 27 243 0500 015
33 27 243 1000 016
33 27 243 2000 017



IEEE 1355
wiring

Connector 1	Connector 2
2-e	1-a
1-e	2-a
2-d	1-b
1-d	2-b
2-c	2-c

Connector 1	Connector 2
1-c	1-c
2-b	1-d
1-b	2-d
2-a	1-e
1-a	2-e