

# DISAI

Automatic Systems

T: 962 448 450 [www.disai.net](http://www.disai.net)

## Ultrasonic Transit-Time Flowmeter

### Features

- Accuracy better than 0.5% of reading
- Wide operating temperature range  
-40F to +212F (-40C to 100C)
- One meter for a wide range of pipe sizes 1-200" (25mm-5000mm)
- Clamp-on sensors are simple to install, leading to lower installation and labor costs
- Clamp-on sensors mean no pipe cutting or process interruption and no plant shut-down
- Hygienic measurement, no risk of contamination, suitable for ultra clean liquids
- Wide bi-directional Flow range of 0 to 40 fps
- Daily, monthly and yearly totalized flow
- Internally configured batch controller makes batch control convenient
- Measurement is independent of fluid conductivity meaning a wider applicability than magnetic meters

**SIERRA**  
INSTRUMENTS  
THE MASS FLOW COMPANY

5 Harris Court, Bldg. L  
Monterey CA 93940  
831/373-0200  
800/866-0200  
FAX: 831/373-4402  
[www.sierrainstruments.com](http://www.sierrainstruments.com)



For information online: [www.sierrainstruments.com](http://www.sierrainstruments.com)

# Model 205 Innova-Sonic™



### Description

**O**ur Innova-Sonic™ ultrasonic flowmeter is a state-of-the-art universal transit-time flowmeter incorporating the latest developments in digital signal processing. Sophisticated electronics coupled with powerful ultrasonic transducers deliver highly accurate flow measurement for liquids in full pipes. While principally designed for clean liquid applications, the instrument is tolerant of liquids with the small quantity of air bubbles or suspended solids common in most industrial applications.

Innova-Sonic™ offers low power consumption, high reliability, and outstanding applicability at an economical price. An easy to read display and clear, user-friendly menu selections make using the instrument simple and convenient. The instrument can be configured via keypad without any additional programming devices, is packaged in a die cast NEMA 4X (IP65) housing, and is available in your choice of non-invasive clamp-on or insertion transducer configurations.

Innova-Sonic™ features a self-contained 4-20 mA current loop signal output for instantaneous flow, as well as two independent temperature inputs for thermal energy monitoring. The instrument also features a 7 digit alphanumeric display, parallel operation of positive, negative and net flow totalizers (with user-selectable scale factors) and configurable pulse and frequency outputs (transmitted via relay and open collector) for totalized flow. SD data logging capabilities is included and energy monitoring is fully supported at no additional charge.

The information contained herein is subject to change without notice.

## Performance Specifications

### Flow Range:

0 to  $\pm 40$  ft/s (0 to  $\pm 12$  m/s)

### Accuracy:

$\pm 0.5\%$  of reading

**Repeatability:**  $\pm 1.0\%$  of reading (for 1.5 to 40 ft/s or  $-1.5$  to  $-40$  ft/s)

**Linearity:**  $\pm 1.0\%$

**Pipe Size:** 1 in to 200 in (25mm to 5000mm)

## Operating Specifications

### Output:

Analog: 0/4 to 20mA (max load 750 $\Omega$ )

Pulse output: 0 to 9999Hz, OCT, (min. and max. frequency is adjustable)

Relay output: SPST, max 1Hz, (1A@125VAC or 2A @ 30VDC) RS232C

**Power Supply:** 90 to 245 VAC, 48 to 63Hz.

Or 10 to 36 VDC (both are standard)

**Keypad:** 16 (4x4) key with tactile action

**Display:** 40 character, 2 line (20x2) lattice alphanumeric, backlit LCD

**Temperature:** Transmitter:  $-40$ F to  $140$ F ( $-40$ C to  $60$ C)

Transducer:  $-40$ F to  $212$ F standard ( $-40$ C to  $100$ C)

**Humidity:** Up to 99%RH, (non-condensing).

## Physical Specifications

**Transmitter:** NEMA 4X (IP65), Die-cast aluminum

**Transducer:** Encapsulated design Standard/maximum cable length:  
30ft/1000ft (9m/305m)

**Weight Transmitter:** Approximately 4.7 lb (2.15kg)

Transducer: approximately 2.0 lb (0.9kg) (standard)

## Typical Clamp On Installation



## Transmitter Dimensional Specifications

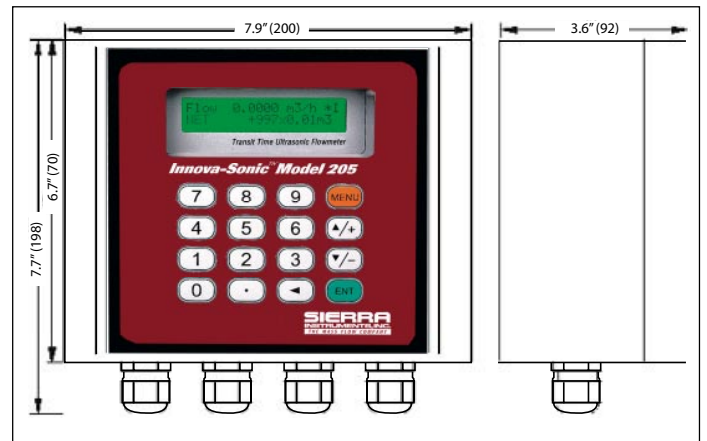

## Transducer Dimensional Specifications

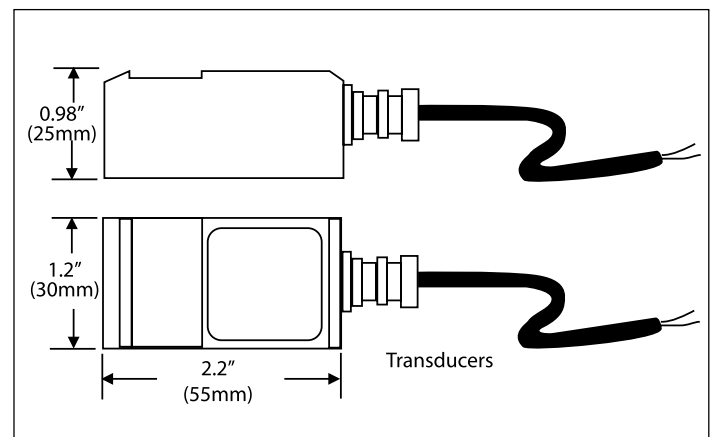

## Typical Insertion Installation



## Suitable Locations

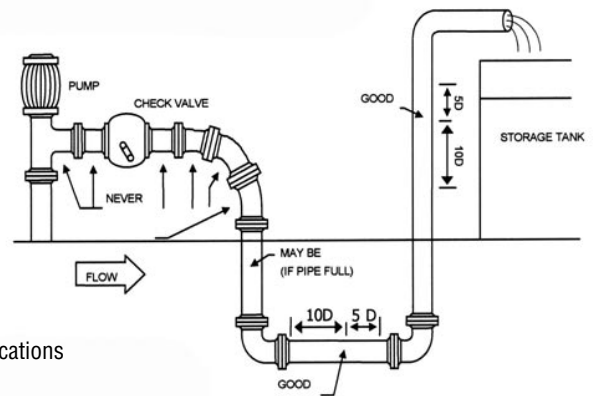
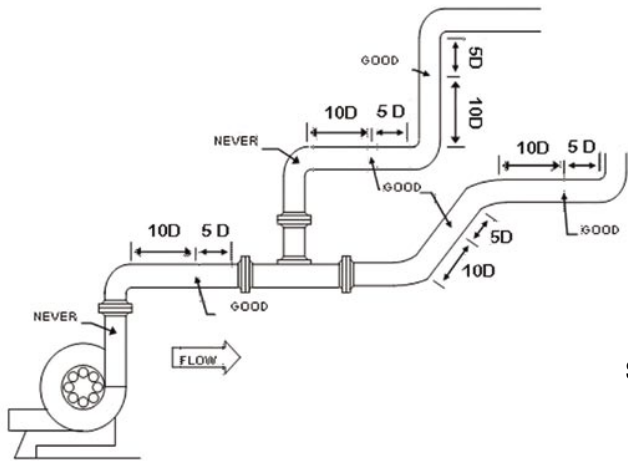

Suitable locations

## Transducer Spacing Requirements

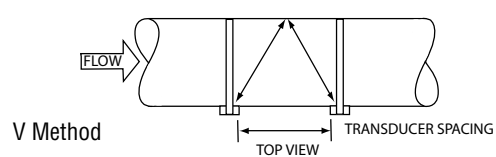
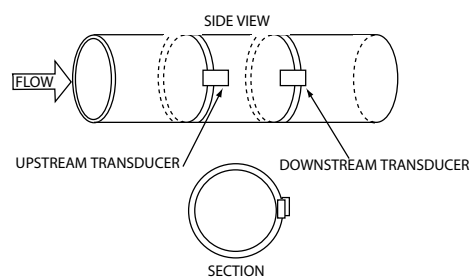
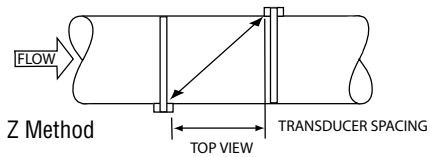
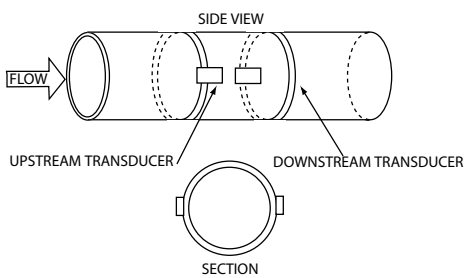

## Insertion Transducer

DIMENSIONAL SPECIFICATIONS-INSERTION SENSOR			
No.	Parts	No.	Parts
1	Cable	7	Set Screw
2	End Connector	8	O-Ring
3	O-Ring	9	Nut
4	Alignment Handle	10	Ball Valve
5	Locking Sleeve	11	Mounting Collar
6	Locking Collar	12	Transducer Housing

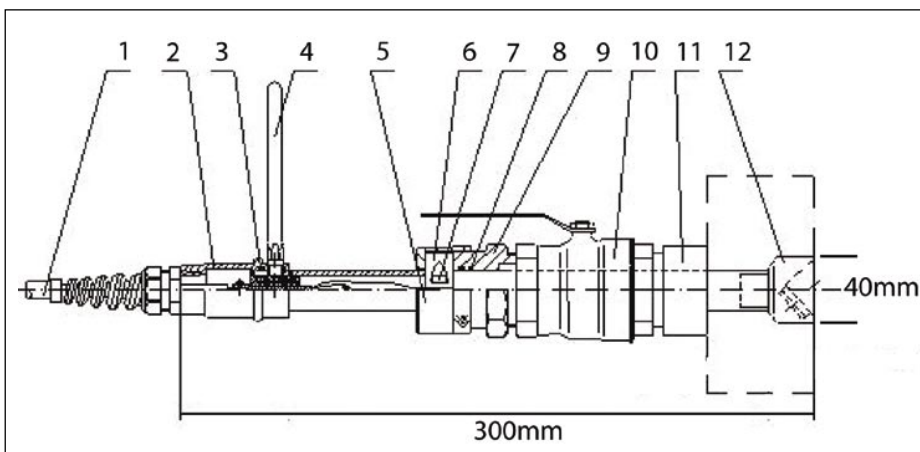

## Ordering the Model 205

