

Heads for Control and Signalling Units



SUMMARY	PAGES
1. Description, use.....	1
2. Range	1
3. Measurement	2
4. Installation	5
5. Technical characteristics	6
6. Compliance and approvals	7
7. Equipment and Accessories	7
8. Restriction	7
9. Miscellaneous.....	7

1. DESCRIPTION - USE

22 mm diameter heads for Control and Signalling Units

2. RANGE (Alternative order code)

. References

L20SA10 to L20SA60, L20SA10L to L20SA60L, L20SA10M to L20SA60M, L20SA10H to L20SA60H, L20SA31xxx to L20SA36xxx, L20SA31Lxxx to L20SA36Lxxx, L20SA31Mxxx to L20SA36Mxxx, L20SA31Hxxx to L20SA36Hxxx, L20SE10 to L20SE60, L20SE31xxx to L20SE36xxx, L21AA00 to L21AA06, L21AA81 to L21AA83, L21AA31xxx to L21AA36xxx, L23AA01 to L23AA06, L23AA81 L23AA82, L23AA31xxx to L23AA36xxx, L22AF01 to L22AF03, L22AG04 to L22AG06, L21AB01 to L21AB06, L21AC01 to L21AC04, L21AD01 to L21AD04, L21AE01, L21AE03, L21CA01 to L21CA06, L21CB01 L21CB02 to L21CB06, L22EC01 to L22EC04, L22DC01, L22ED01 to L22ED04, L22ED01B, L22DD01, L22DD03, L22GM01, L22DQ01 L22GQ01, L22DR01, L22ER01, L22GR01, L22DU01A, L22DU01, L21KA01 to L21KA08, L21KB01 to L21KB08, L21KC01 to L21KC08, L21KE01 to L21KE08, L21KF01 to L21KF08, L21MA01 to L21MA08, L21MB01 to L21MB08, L21MC01 to L21MC08, L21MD01 to L21MD08, L21MK01 to L21MK08, L21KP01 to L21KP08, L21KQ01 to L21KQ03, L21KR01 to L21KR03, L21KS01 to L21KS03, L21KT01 to L21KT03, L21KU01 to L21KU03, L21MR01 to L21MR08, L21MS01 to L21MS08, L21MT01 to L21MT08, L21MU01 to L21MU08, L21TA03, L21TB03, L21TF03, L21UA03, L21UB03, L21UC03, L21UD03, L21UK03, L21LA00, L21LB00, L21LC00, L21LD00, L21LF00, L21LG00, L21LH00, L21LK00, L21NA00, L21NB00, L21NC00, L21ND00, L21NE00, L21NJ00, L21NK00, L21NL00, L21HA01 to L21HA06, L21HA31xxx to L21HA36xxx, L21HB01 to L21HB06, L21RP03, L61QB21, L61QB21B, L62QM21, L61QA21, L61QA22, L61QA22K, L61QA33C, L61BA22, L61BA22B, LM2F, LM2A, LM4F, LM4A, LMV2F, LMV2A, LMV4F, LMV4A, L21AH00 to L21AH60, L21AH31xxx to L21AH36xxx, L22AP10 to L22AP60, L23AH10 to L23AH60, L23AH31xxx to L23AH36xxx, L21AK10 to L21AK60, L21AL10 to L21AL50, L61QH21, L61QH22V, L61QH21A, L61QK21, L61QK53, L61QK21A, L61QN21, L21CH10 to L21CH60, L23CH10 to L23CH60, L21CK10 to L23CK60, L22EL10, L22DL10

2. RANGE

L22EM10 to L22EM40, L22DM10 to L22DM50, L22DN10, L22EM10 to L21KG10 to L21KG30, L21KH10 to L21KH30, L21KJ10 to L21KJ30, L21KK10 to L21KK30, L21KL10 to L21KL30, L21KM10 to L21KM30, L21ME10 to L21ME30, L21MF10 to L21MF30, L21MG10 to L21MG30, L21MH10 to L21MH30, L21MJ10 to L21MJ30, L21KV30, L21KX30, L21KY30, L21ML30, L21MM30, L21MP30,

. Heads :

- Spring return
- Stay-put
- Selector switch
- Mushroom head Push Pull EN 418 / ISO 13850
- Mushroom head Push Pull
- Mushroom head Push Pull with flag indicator
- Mushroom head Push Turn EN 418 / ISO 13850 with or without key to reset
- Mushroom head Push Turn with or without key to reset
- Spring return Mushroom head
- Twin Touch
- Triple - Touch
- Pilot light
- One piece pilot light
- Super Flush
- Adjustable Mechanical Push/reset Button
- Potentiometer knob

. Mounting :

- with electrical contacts blocks, except:
 - . One piece pilot lights
 - . Adjustable Mechanical Push/reset button
 - . potentiometer
- With led blocks on illuminated heads and Pilot lights
- In or out enclosure

3. MEASUREMENT

Flush Spring return push- buttons and stay-put

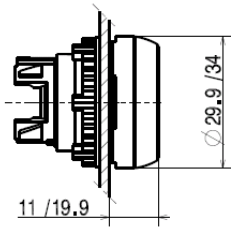

(without silicon shroud/ with silicon shroud)

Projecting Spring return push- buttons and stay-put

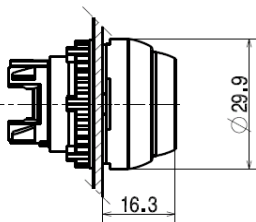

Spring return Mushroom head

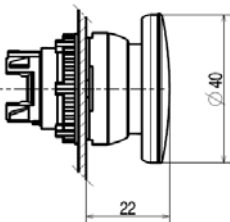

**Double touch
- Flush / Flush**

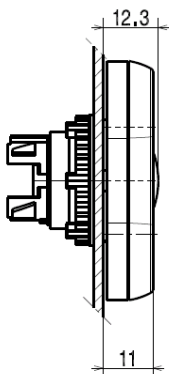

3. MEASUREMENT

- Flush / Projecting

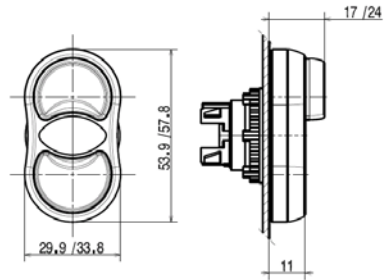

(without silicon shroud/ with silicon shroud)

Super Flush

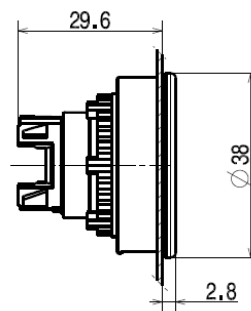

Selector switch with handle

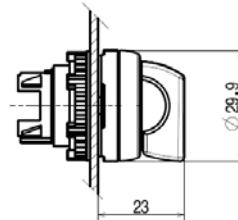

Selector switch with long handle

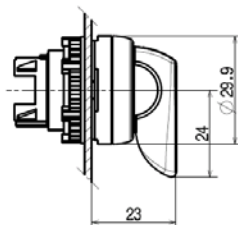

3. MEASUREMENT

Selector switch with key

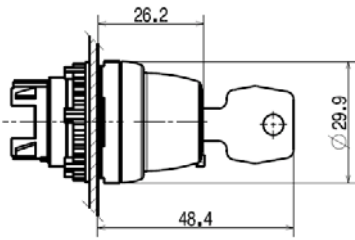

Selector switch with knob

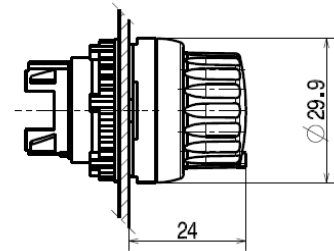

Mechanical operation for 3 position selector switches

Back side view

Non operated block

Operated block



Handle position

(Front side view)



Contacts block

actuation

(Back side view)



Mushroom head EN418 / ISO 13850 Ø 32 push-pull stay-put

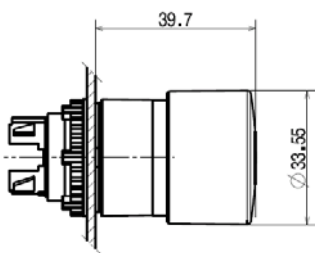

3. MEASUREMENT

Mushroom head Ø 40 Push-pull Stay -put

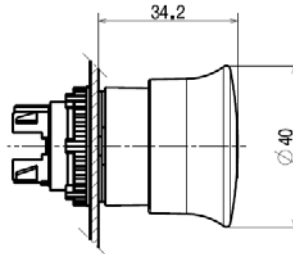

Mushroom head EN418 / ISO 13850 Ø 40 Push-pull Stay-put

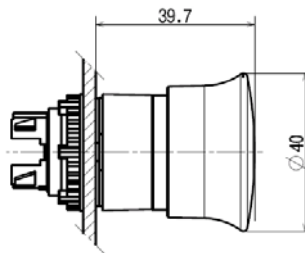

Mushroom head EN418 / ISO 13850 Ø 54 Push-pull Stay-put

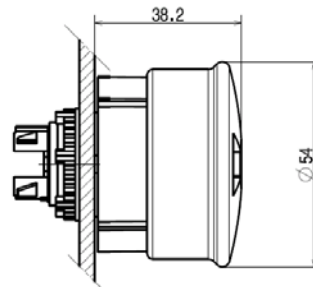

Mushroom head Push-turn Stay-put

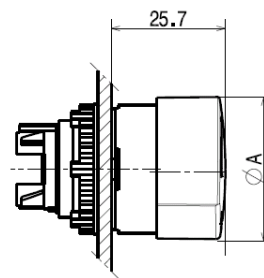

Ref L22EC01/03 ØA = 32 mm

Ref L22ED01/03/01B ØA = 40 mm

3. MEASUREMENT

Mushroom head EN 418 / ISO 13850 Push-turn Stay-put

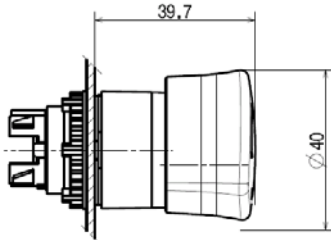

Mushroom head Stay-put Key to reset

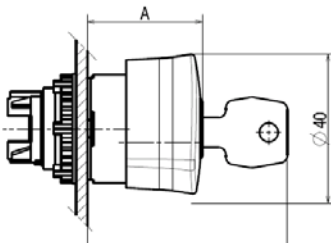

Ref	A (mm)	B (mm)
L22GM01	30.7	53.7
L22GR01	40.8	63.8

Joysticks (head supplied with a 3 position clip – Specific electric blocks LM11)

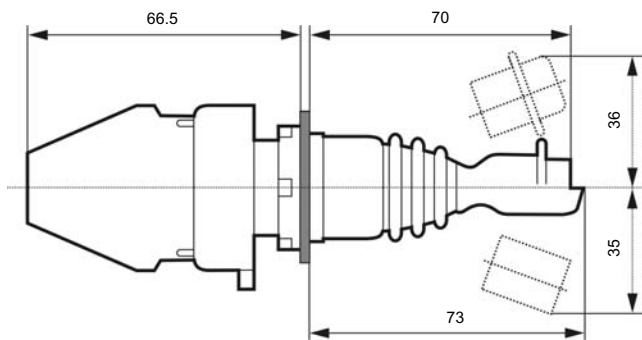

Mechanical operation for Joysticks

2 positions

A			A	0	B
0	LM11	13	14	X	
B	in pos n° 1 on clip	11	12		X

4 positions

A			A	C	0	B	D
D	LM11	13	14	X			
0	in pos n° 1 on clip	11	12				X
B	LM11	23	24			X	
	in pos n° 2 on clip	21	22	X			

3. MEASUREMENT

Potentiometer knob

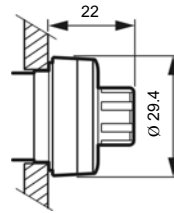

Adjustable Mechanical Push / reset Button (BAM)

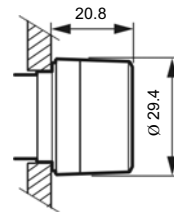

Pilot light

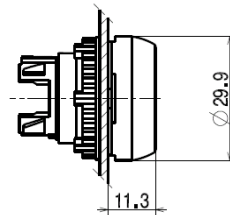

One piece pilot light

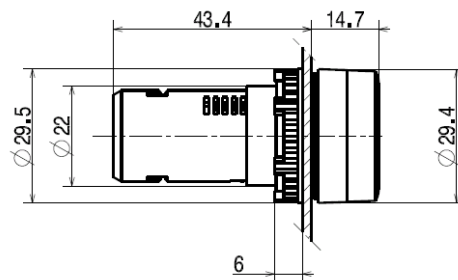

4. INSTALLATION

Drilling:

Standard drilling (products fitted with screw and plug-in connection). Panel thickness: 1 to 6 mm

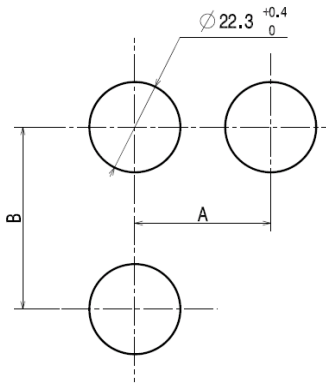

		Dimension (mm)	
A	=	30	With or without legend (usual case)
	=	33	For silicon shroud IP67
	=	40	With large legend plate
	>	40	For Mushroom head $\varnothing 40$
	>	45	For selector switch with long handle
	=	38	For super flush button
B	=	50	With 5 position clip
	=	45	With or without legend (usual case)
	=	54	With double touch
	=	77	With double touch + legend plate

Drilling when using the anti rotation tab

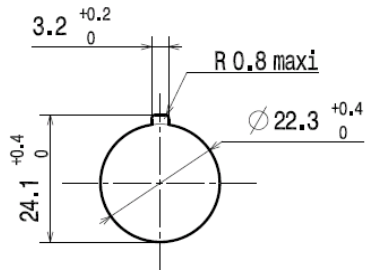

Drilling for super flush button

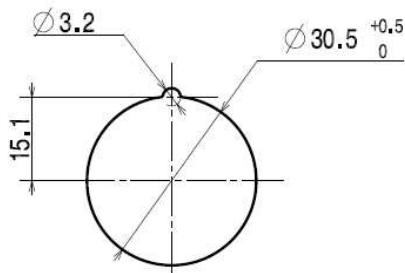

4. INSTALLATION

Mounting :

- . on one position clip
- . Head+clip assembly

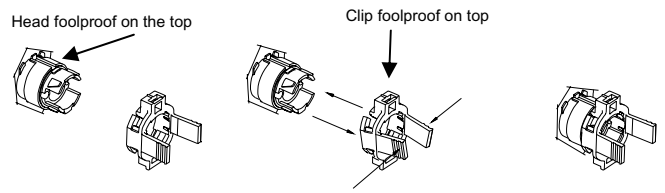

- . clip+block assembly / removal

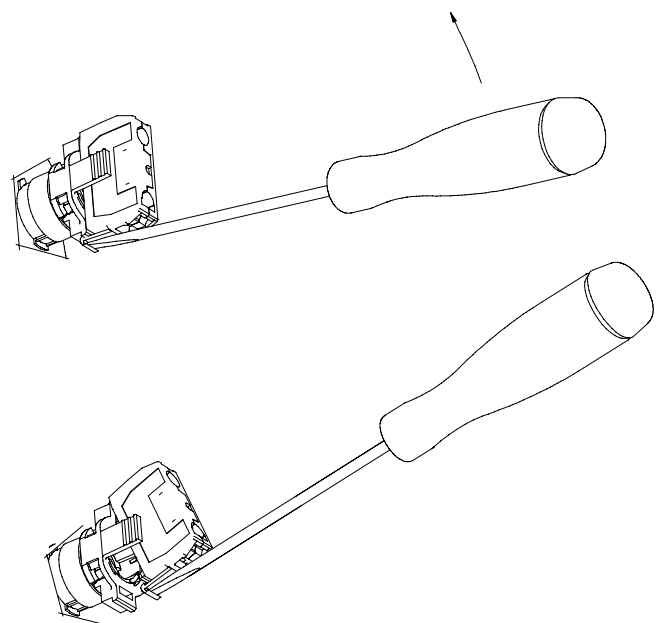
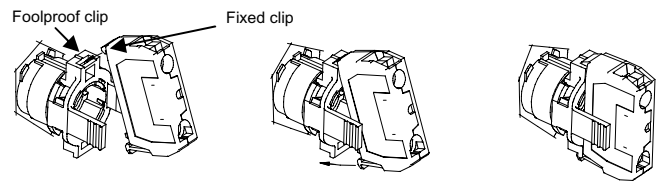

- . on 3 or 5 position clip
- . Head+clip assembly

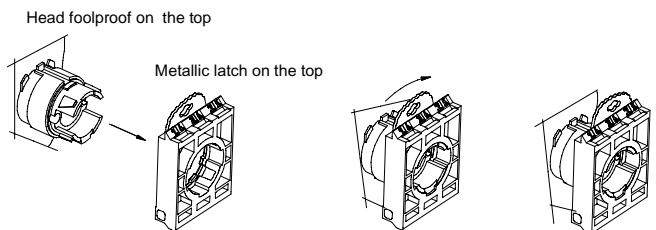

4. INSTALLATION

. clip+block assembly / removal

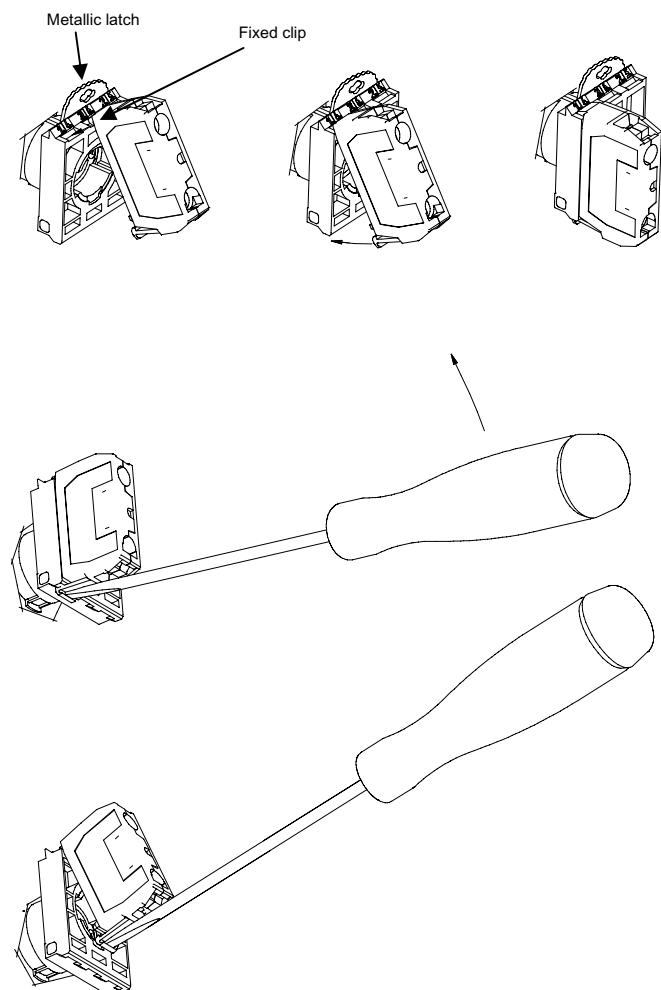

Tools:

. Fixing tool for locking ring LWA0234

Frames :

- . With legend plates
- . Frame multi directionnal at 90°
- . 5 colours legend plates blank or engraved
- . Round legend plate for mushroom head
- . Button plates for spring return and stay-put button

5. TECHNICAL CHARACTERISTICS

Protection index :

- . IP 66 and NEMA 4x,12,13 for standard heads
- . IP 67 with silicon shroud
- . IP 20 at the back of panel for the one piece pilot lights

Protection against mechanical impact:

- . IK 05 for heads

5. TECHNICAL CHARACTERISTICS

Electrical characteristics for One piece pilot light with Led

Operating voltage :

- 12 to 24 V AC/DC (+/- 10%)
- 130 V AC (+/- 10%)
- 230 V AC (+/- 10%)

Terminals :

Screw terminals

Consumption :

For all voltage : less than 15 mA

Insulation voltage :

300 V

Pollution degree :

3

Rated impulse withstand voltage Uimp :

4 kV (with filter block)

Electrical characteristics for One piece pilot light with BA9S bulb

Power :

2.6 W maxi

Insulation voltage :

300 V

Rated impulse withstand voltage Uimp :

4 kV

Tightening torque for locking ring :

. Recommended 3 N.m.

Electrical insulation :

. Classe II according to IEC 60947-5-1

Operating temperature ambiante :

. minimum : -25°C maximum : +70°C

Storage Temperature :

. minimum : -40°C maximum : +70°C

Cold test :

. according to IEC 60068-2-1

Dry heat test :

. according to IEC 60068-2-2

Constant humidity test :

. according to IEC 60068-2-30

5. TECHNICAL CHARACTERISTICS

Mechanical endurance: (in millions cycles)

- . Spring return: 5
- . Push-Push : 0,5
- . Selector switches: 0,3
- . Mushroom head maintained function EN418 / ISO 13850 : 0,1
- . Mushroom head maintained function : 0,15

Activation Force in N :

- . Spring return + NO : 6,5
- . Spring return + NCO : 4,5
- . Additional NO contact : 4,5
- . Additional NC contact : 3
- . Push-pull Mushroom head+ NO + NC : 27
- . Push-turn Mushroom head+ NO + NC : 22
- . Push-pull Mushroom head EN418 / ISO 13850 + NO + NC : 37
- . Push-turn Mushroom head EN418 / ISO 13850 + NO + NC : 60

Activation Force in Nm :

- . Selector switches + NO : 0,04
- . Additional NO contact : 0,03

Packaging :

- . By 1, 5 or 10

6. COMPLIANCE AND APPROVALS

Standard compliances:

- . IEC 60947-5-1
- . IEC 60947-5-5
- . IEC 60947-5-4
- . UL 508
- . CSA 22.2
- . BV Marine rules

Approvals:

- . cULus
 - . BBJ
 - . Bureau Veritas (Marine rules)
- Environmental respect.

- . Compliant to the directive 2002/95/CE of 27/01/03 « RoHS » restricts the use of hazardous substances like lead, mercury, cadmium, hexavalent chromium, poly brominated diphenyls (PBBs) and poly brominated diphenyl ethers (PBDEs) since July 1st 2006
- . Compliant to the directives 91/338/CEE of 18/06/91 and decree 94-947 of 27/07/04

- . Compliant to the directive 72/23 CEE and 89/339 CEE on the CE marking

- . Compliant to the directive 73/374 CEE (98389 rule of the 15/05/98)

- . Compliant to the directive 76/769/CEE concerning hazardous substances prohibition

UV resistance:

- . UV resistance according to UL 746C 6th edition, §25

6. COMPLIANCE AND APPROVALS

Plastic materials :

- . Plastic material body halogen free
- . Polycarbonate
- . PA 6.6 fiber glass loaded
- . Shroud : silicone

EMERGENCY STOP ACTUATORS - EN 418/ISO 13850:

According to IEC/EN60947-5-5, the emergency stop function can be provided by an EN418/ISO13850 mushroom head combined with a "positive opening" NC contact block. The mechanism of our EN418/ISO13850 mushroom heads is so designed that a "push" action of sufficient force to open the contact systematically triggers an irreversible locking of this opening. This generates an "emergency stop" signal which can be cancelled only by deliberate manual resetting of the mushroom head (pull and turn or unlocking by key). This function allows to generate an "emergency stop" signal for any equipment subject to directive 98/37CE (machinery safety) completed by the IEC 60204-1 standard. The EN418/ISO13850 mushroom heads also comply with the safety requirements detailed in standards EN418 and ISO13850.

Packaging:

- . Packaging development and manufacturing conform to the decree 98-638 of 20/07/98 and to the directive 94/62/CE

7. EQUIPMENT AND ACCESSORIES

Mounting:

- . with 1 position clip : 1 contact block or led
- . with 3 position clip : 1 to 6 blocks (on 2nd row) whose 1 illuminated block (central position 1st row)
- . with 5 position clip: 1 to 5 blocks inc. 1 illuminated block (central position)

8. RESTRICTION

- . Push-turn Mushroom head EN 418 / ISO 13850 (with or without key) : restriction to 5 NC blocks maxi or 6 NO blocks
- . Other heads:
 - illuminated: 4 contact blocks + 1 illuminated block
 - non illuminated: 6 contact blocks (except Push-turn EN 418 / ISO 13850)
- . All heads :
 - The NO/NC contact block can't be mounted on a 2nd row

9. MISCELLANEOUS

- . Key selector switch and mushroom head key to reset: 455 key usual case